

# hyperCAD<sup>®</sup>

© The helmet was programmed and produced by DALSHIN



## CAD for CAM

CAD-INTEGRATION

 **OPEN MIND**  
THE CAM FORCE

# In a class of its own among CAD systems

Only a high-end CAM developer can do CAD for CAM. With this in mind, Open Mind Technologies AG – known as an innovative pioneer – developed a new CAD system from scratch that is perfectly matched to *hyperMILL*<sup>®</sup>. The system has its own 3D CAD kernel from OPEN MIND. The result is a unique CAD system for CAM programmers that is very easy to learn and that vastly accelerates NC programming processes.

*hyperCAD*<sup>®-S</sup> fully exploits the performance offered by contemporary hardware systems to create digital manufacturing data. The advanced and extremely powerful 64-bit system is the perfect solution for mastering many of the daily challenges that arise when working with meshes, faces and solids to create precise components and tools. Large volumes of imported data can be prepared for subsequent NC programming easily, quickly and safely and completely independently from the original CAD system. *hyperCAD*<sup>®-S</sup> is pure ‘CAD for CAM’.

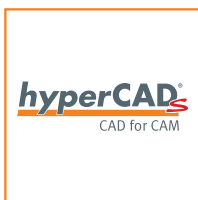

Interfaces

Geometric  
Engine

Solids

Mesh

Deformation

“At last we’ve got a CAD system for CAM programmers!”

Stefan Nagel, Deputy Managing Director of Kiefer Werkzeug- und Vorrichtungsbau, Pfullingen

## Features

- CAD for CAM
- 64-bit multi-application
- Top performance
- Optimal ergonomics
- Highly intuitive
- Optimal hardware utilisation

## CAD for CAM

CAM programmers use CAD systems differently from most engineers and designers. *hyperCAD*®-S is therefore designed entirely to meet the demands of CAM users. Efficient CAM programming is of primary importance and perfectly supported by the CAD system.

- **Customisable filter functions:** In addition to familiar properties such as layer and colour, the most common geometric and system properties are available as user-defined filters.

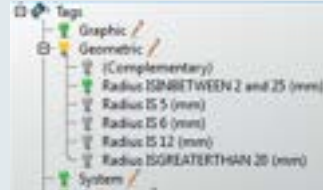

**Keyword navigation:** Graphic entities can be linked using tags, similar to keywords. This makes it easy to filter all the information about the CAD model. For example: ‘All faces with a radius between 2 and 20 mm’.

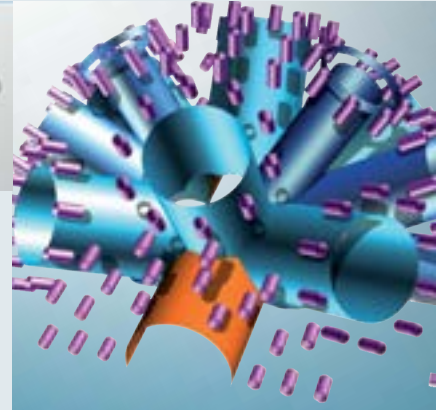

- **Intelligent entity management:** Toolpaths, polygon meshes, point clouds, rectangles – the inclusion of CAM-relevant entities in the CAD kernel speeds up processes greatly.
- **Multi-application mode:** An integrated 64-bit system and IDE-style interface enable opening any number of documents each in its own application. Multiple models can be processed and calculated at the same time.
- **Smooth data exchange:** comprehensive interface package. **Import:** Standard: IGES, STEP, STL, DXF/DWG, Parasolid®, point cloud, *hyperCAD*®. Direkt: CATIA V4® and V5®, Autodesk® Inventor®, Siemens NX®, SOLIDWORKS, PTC® Creo. **Export:** IGES, STEP, STL, DXF/DWG, point cloud and *hyperCAD*®.
- **Intuitive operation:** Self-explanatory icons and a highly transparent user interface without any hidden functions secure and accelerate operating procedures.
- **All languages:** Available in all the same language versions as *hyperMILL*®.

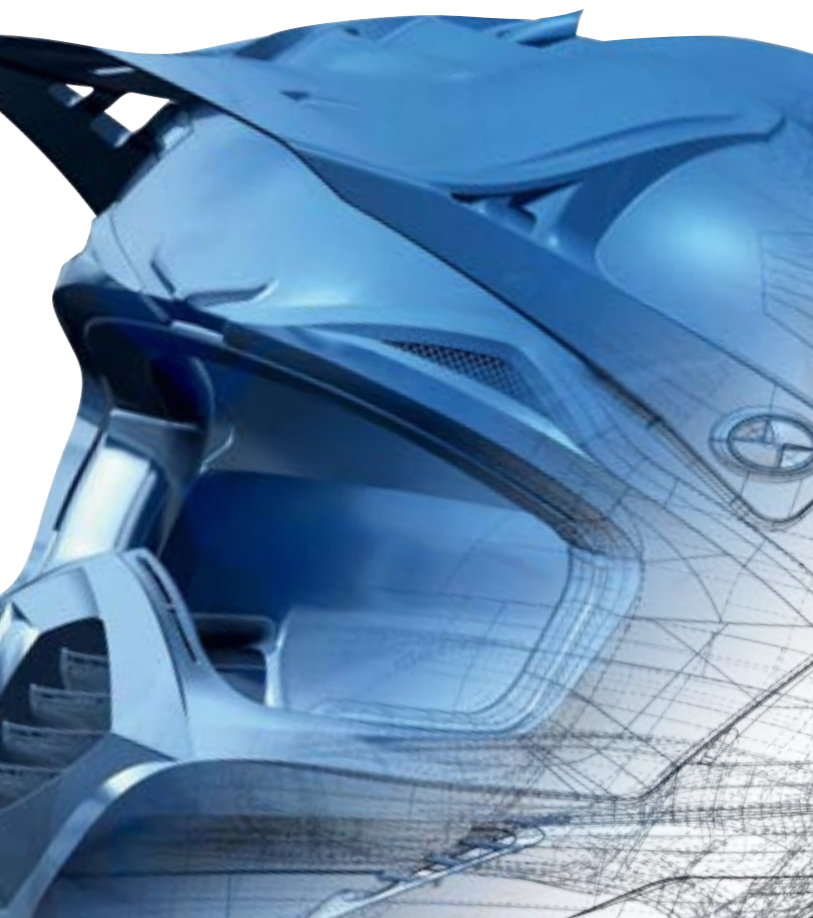



# Geometric Engine – the right CAD basis from the start

Every CAM programmer is familiar with the standard CAD tasks of selecting, adding, deleting, modifying, showing and hiding faces, curves and points. Users expect top-quality results from the ruled, filling and offset faces that they create. *hyperCAD®-S* offers all this and much more. OPEN MIND took great care when developing the CAD innovation to adapt the range of CAD functions to meet the real needs of CAM programmers rather than designers.

Instead of relying on numerous distributed submenus (as is the case in conventional design systems), *hyperCAD®-S* uses central, user-friendly dialogues with large icons. Smart selection mechanisms and innovative, freely definable filter functions make it considerably easier to use geometric entities for subsequent programming. Imported geometry can be cleaned quickly if needed using standard surface modifying tools.

Close holes From limits  
Rotational face Along a guiding line  
Plane **FACES** Fill face  
Ruled face Limited plane  
From cutting curves Trim  
Offset Linear extrusion  
Invert orientation  
Shape contour Project  
Penetration Splines  
Isoparametric **CURVES** Split  
Machine interpolation control points Join  
Lengthen/shorten From limits  
2D/3D spiral Adjust  
Join Trim automatically  
Centres curves

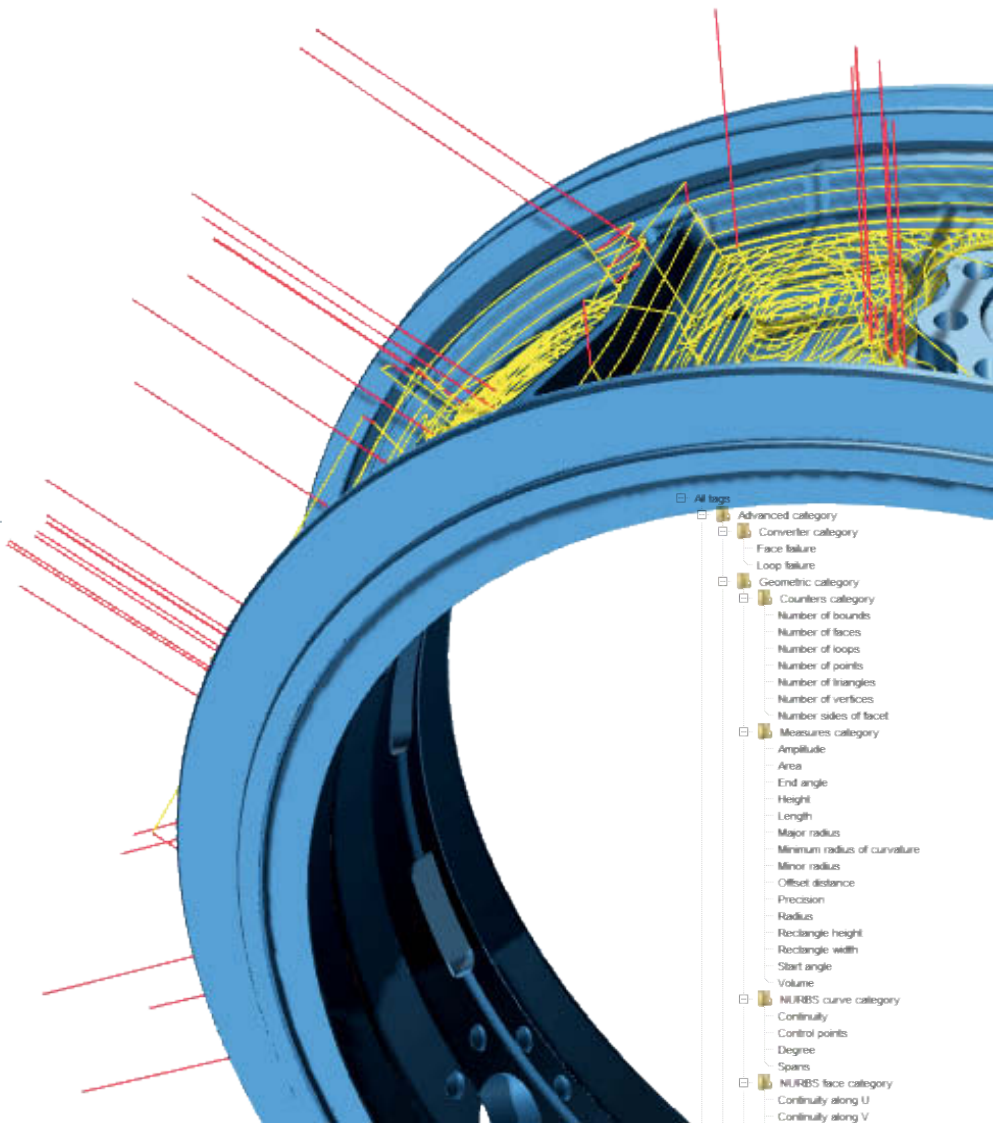

- **Fully compatible with hyperCAD®:** It goes without saying that *hyperCAD®-S* is compatible with *hyperCAD®*. All versions are fully supported: E3, E2 and GKD files, job lists and entity selection.

- **A new way to navigate:** Powerful navigation and selection functions provide support for working with large models.

- **Fast repairs and modifications:** As every CAM programmer knows, most imported external data records contain errors. *hyperCAD®-S* therefore contains a number of repair functions designed to speed up subsequent CAM processes. Geometry areas can also be easily edited at any time.

- **Comparing geometries:** A fast geometry comparison immediately shows where exactly new versions of customer components have changed.

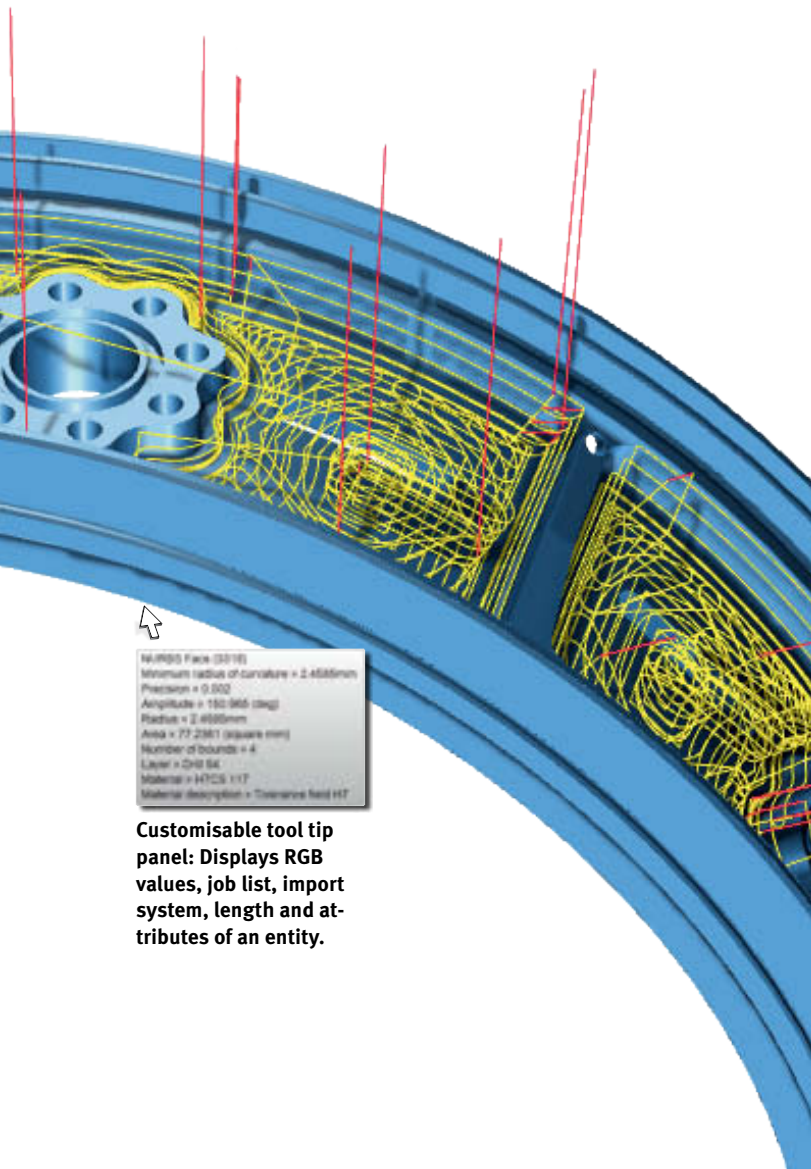

NAME: Face (3376)  
 Minimum radius of curvature = 2.4585mm  
 Precision = 0.002  
 Amplitude = 130.965 (deg)  
 Radius = 2.4585mm  
 Area = 77.2361 (square mm)  
 Number of bounds = 4  
 Layer = 010 04  
 Material = 477CS 117  
 Material description = Titanium Ti64 HT

**Customisable tool tip panel:** Displays RGB values, job list, import system, length and attributes of an entity.

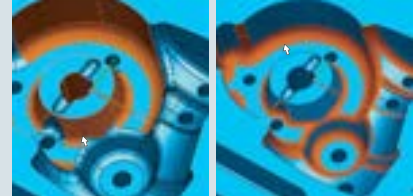

Coaxial

Fillets

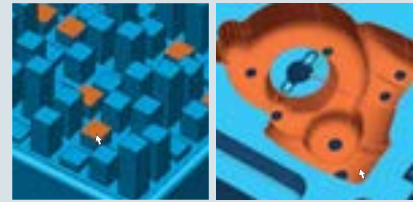

Coplanar

Tangential

**Smart selector technology for faces and skins:** various selection options for curves: 'from...to' chain selection and for faces: tangential, limited, coaxial, coplanar, fillets and chamfers.

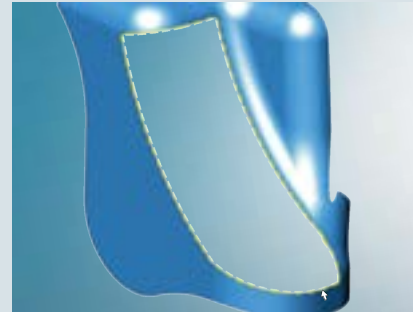

**Planar and non-planar filling faces:** Faces that are to be filled can be automatically closed – at face edges as well.

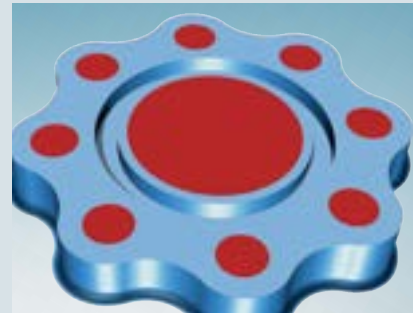

**Multiple work planes:** It is possible to define multiple work planes. Saved work planes make it easy to perform transformations. They can also be imported to other files at any time.

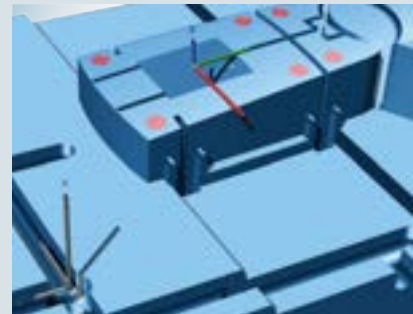

**Standard preparation for milling:** It is easy to create frequently required building, extension, machining and stop faces in a structured manner.

This is also the case with boundary and guide curves as well as construction aids, planes and axis systems.

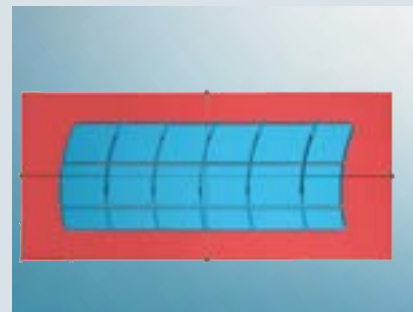

**Practical analysis functions:** The analysis functions allow draft areas and highly complex geometries to be located quickly and reliably. This enables assessing the quality of an existing component immediately. Problems are recognised quickly.

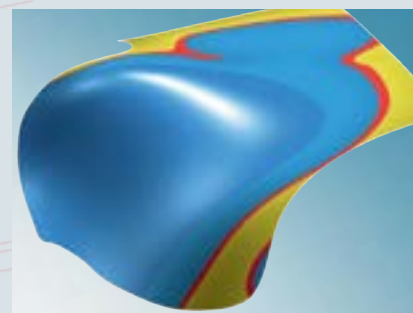

# Solids – efficient solid modelling

*hyperCAD*<sup>®</sup>-S Solids – the module for solid modelling – was, of course, also developed primarily for CAM programmers. In contrast to engineers and designers, this group requires features without a history tree during solid modelling. Why make it complicated if doing it directly is quicker? With the innovative approach to direct modelling offered by *hyperCAD*<sup>®</sup>-S Solids, solid modelling becomes a real joy: After the faces or features of a solid model have been selected, the position and shape of the faces of the solid model can be modified in real time simply by dragging handles and manipulators. And the best thing is that direct modelling does not only work with native data but also with external data that have been imported and have no feature history information.

The *hyperCAD*<sup>®</sup>-S Solids module allows all solid models to be reliably imported, created, converted, modified and combined. Working with solid models becomes noticeably easier and much more intuitive: Chamfers, fillets and holes can be directly moved, reduced, enlarged or deleted by means of recognised features. The use of existing features and associated functionalities allows CAM programmers who work with faces and solids to be more productive and flexible.

## Features

- Direct modelling
- Numerous features
- More convenient
- Adds flexibility

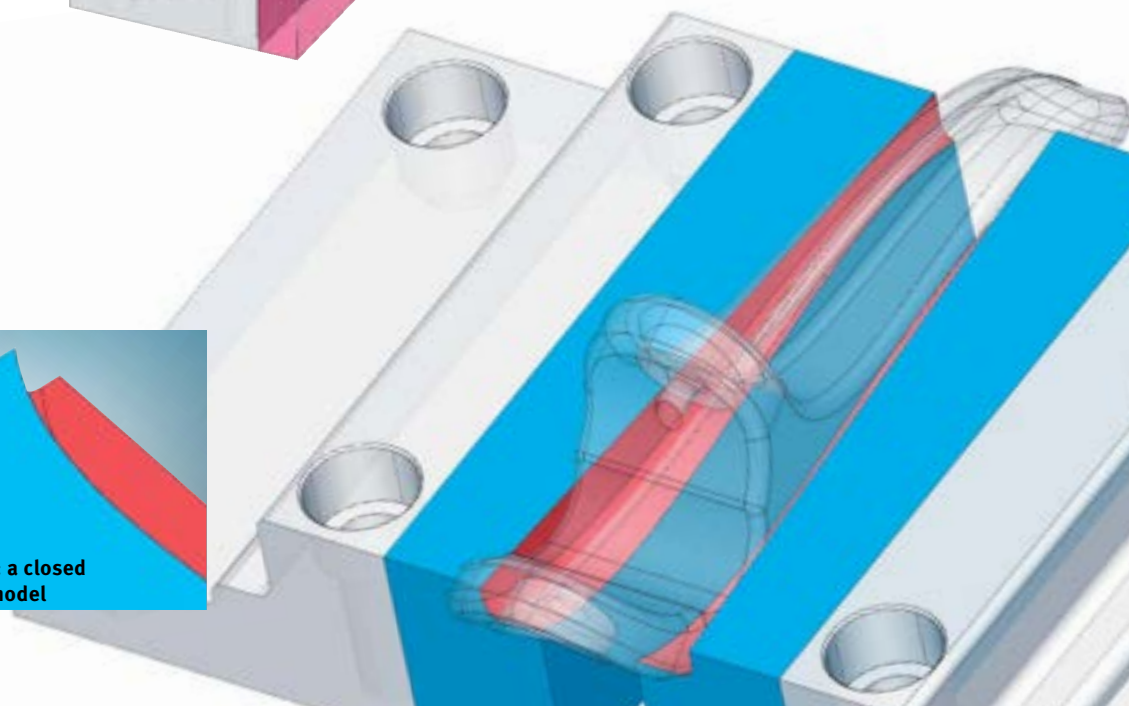
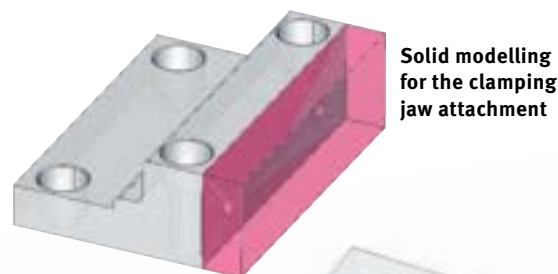



## Standard features

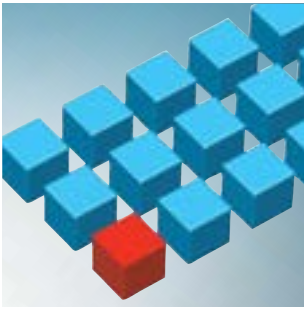

Pattern

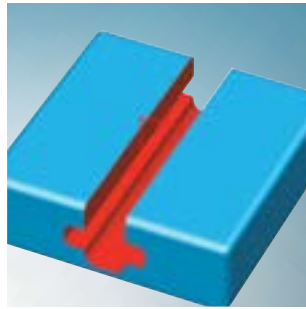

Linear slot

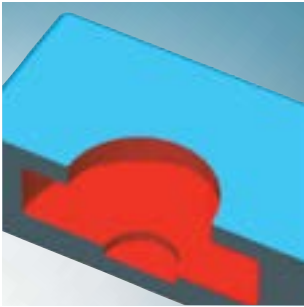

Rotational slot

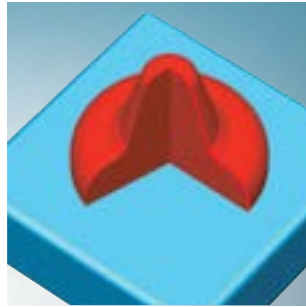

Rotational protrusion

- **Reliable import of external data:** When external data are imported, they are handled in the same way as native CAD data. All construction data, such as sketches, faces, single parts or complete machining groups, are transferred and can be modified, if required.

- **Numerous standard features:** Basic structures, linear extrusions, rotational solids, linear and rotation slots, pockets, simple and complex holes, patterns, chamfers and fillets can be created.

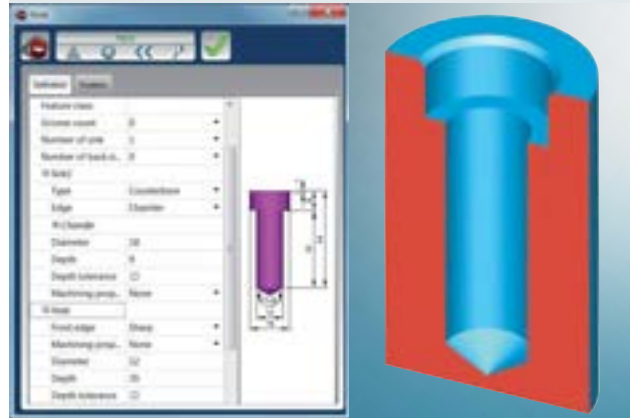

- **Time-saving zone feature:** The zone feature also allows creating user-specific features. Zones can be transformed, copied, deleted or also selected with *hyperMILL*®.

- **Creating solid models from faces:** All it takes is a few clicks to create solid models quickly from closed face formations – and vice versa.

- **Working conveniently with features:** Features that have been created have no history and are not arranged in any particular way. They are stored in the model tree for easy selection. The faces of features can be moved using drag-and-drop operations, in order, for example, to reposition holes. After direct modelling, the shape is recalculated automatically by the system. A wide range of functions are available for machining the features: Delete, mirror, arrange as pattern, offset, move, scale and break.

- **Reliable feature recognition:** Double-clicking an imported face starts the feature recognition. Fillets and chamfers that are recognised are created automatically as features whose dimensions can then be modified again with a smart click.

- **All Boolean operations:** Union, Difference, Intersection and Split.

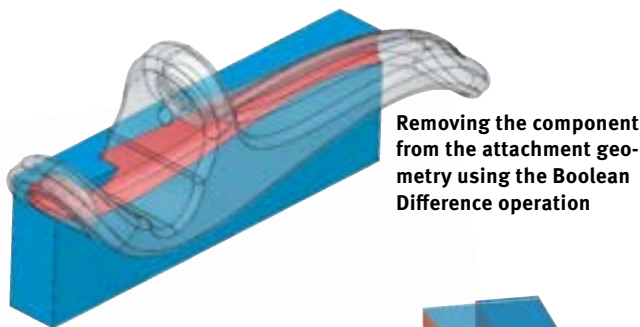

Removing the component from the attachment geometry using the Boolean Difference operation

Direct modelling to widen the attachment

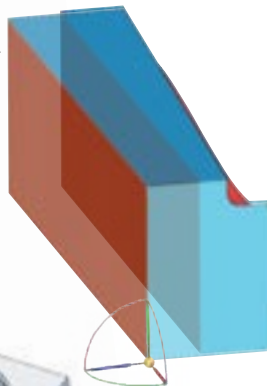

# Mesh – Preparing meshes quickly for milling

Scanned, forged and cast parts, clay models and moulds: 3D surface scanners have a wide range of uses. 3D scanners offer precise, high-resolution, full views of 3D objects, mostly combined with a large quantity of data.

The main task of the CAM programmer is to generate a perfect basis for milling a mesh very quickly from a set of scanned data. In order to achieve the best possible milling results, the CAM programmer can use *hyperCAD®-S Mesh* to repair any possible mesh deviations very quickly, perform metrological analyses and checks and prepare meshes conveniently for milling. Six new functions are available for machining meshes.

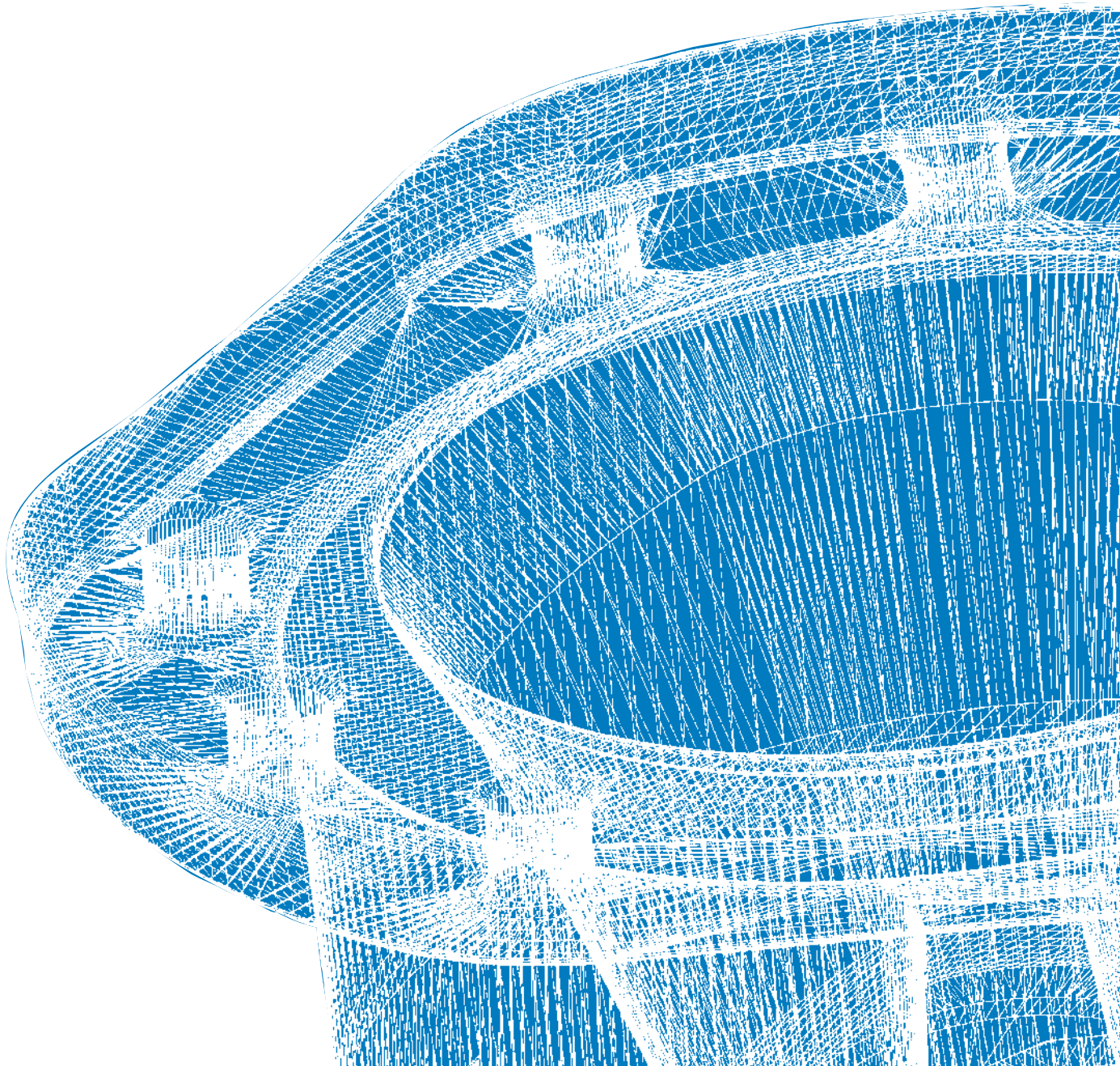



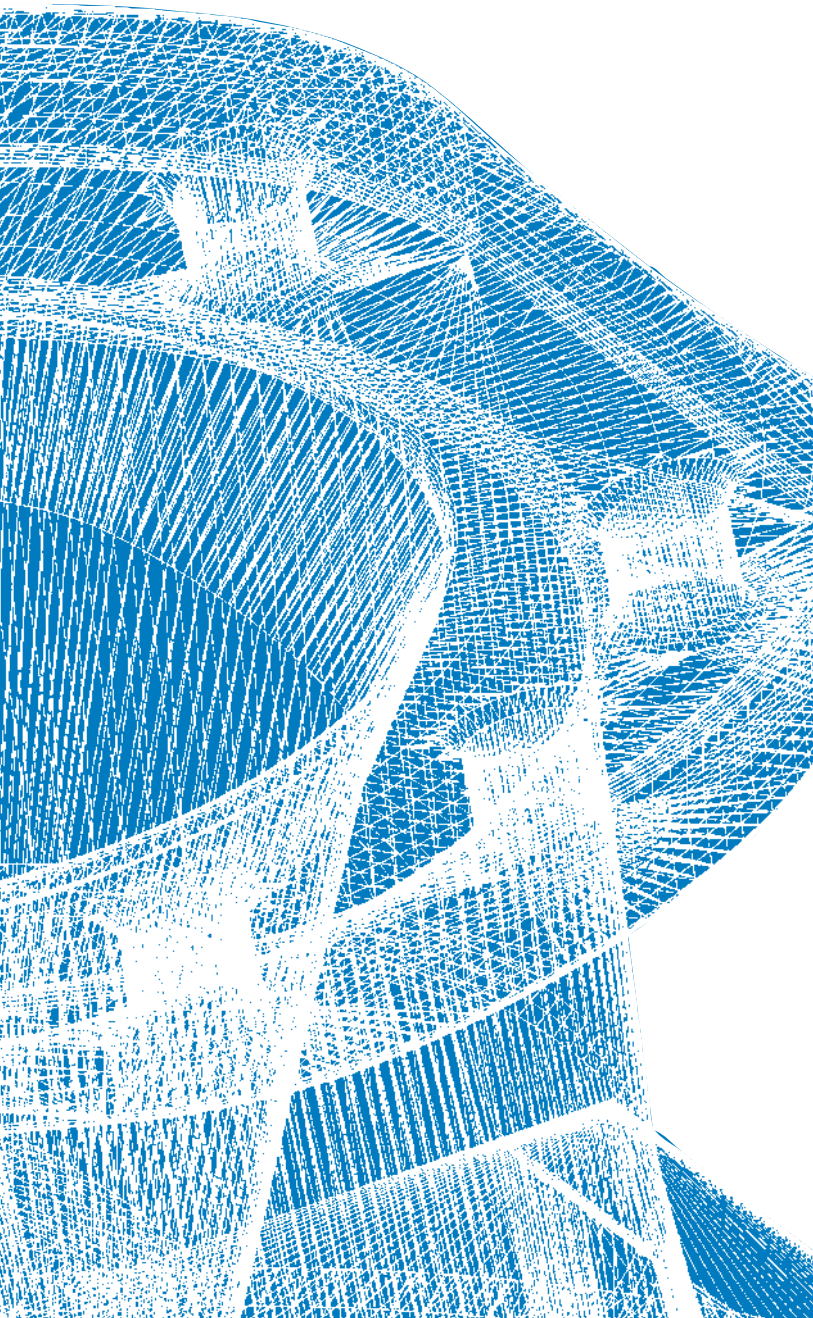

## Mesh functionalities

### ■ Smooth meshes

This function allows the user to smooth meshes in order to repair deviations.

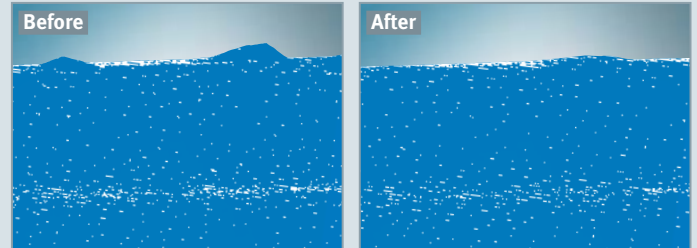

### ■ Decimate meshes

This function allows the user to reduce the mesh density while retaining the geometry properties. The reduced data volume helps to accelerate the model calculation.

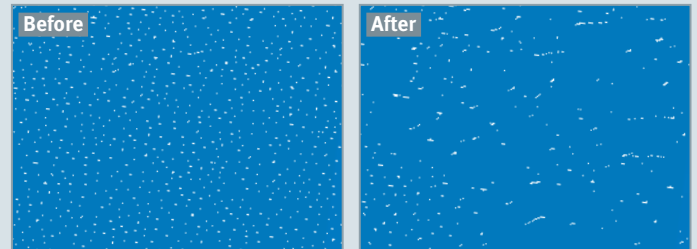

### ■ Fill mesh areas

This provides a simple and convenient way to close holes in meshes.

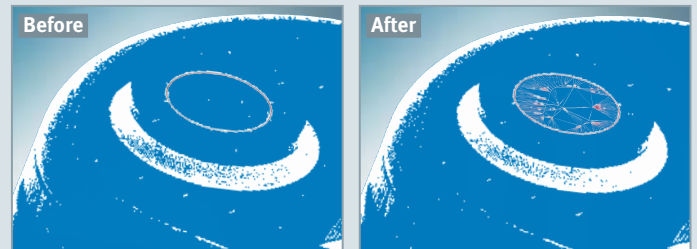

### ■ Separate mesh clusters

This function allows the user to delete meshes that are not connected.

### ■ Mesh from faces

A mesh can be generated from faces, open and closed solids.

### ■ Split meshes

Mesh elements can be split using a planar entity. All the cut triangles are regenerated to ensure that a smooth cut is achieved.

# hyperCAD<sup>®</sup>-S deformation – targeted deformation of geometries

The targeted deformation of geometries is an important requirement placed on CAD systems by design and CAM programming. CAM users need to be able to deform geometries so that they can produce variants and complex geometries as quickly as possible. Experienced CAM programmers modify geometries in order, for example, to overbend tools or manufacture precision parts.

In *hyperCAD*<sup>®</sup>-S, the Deformation module is used to deform all geometries in accordance with their requirements. This powerful modification tool allows modifying global and local component areas in a way that would be very costly using traditional modelling techniques.

**Go faster to the desired end geometry!**

## Features

- Schnell Fast and simple
- Deform entities
- Volumetric deformation

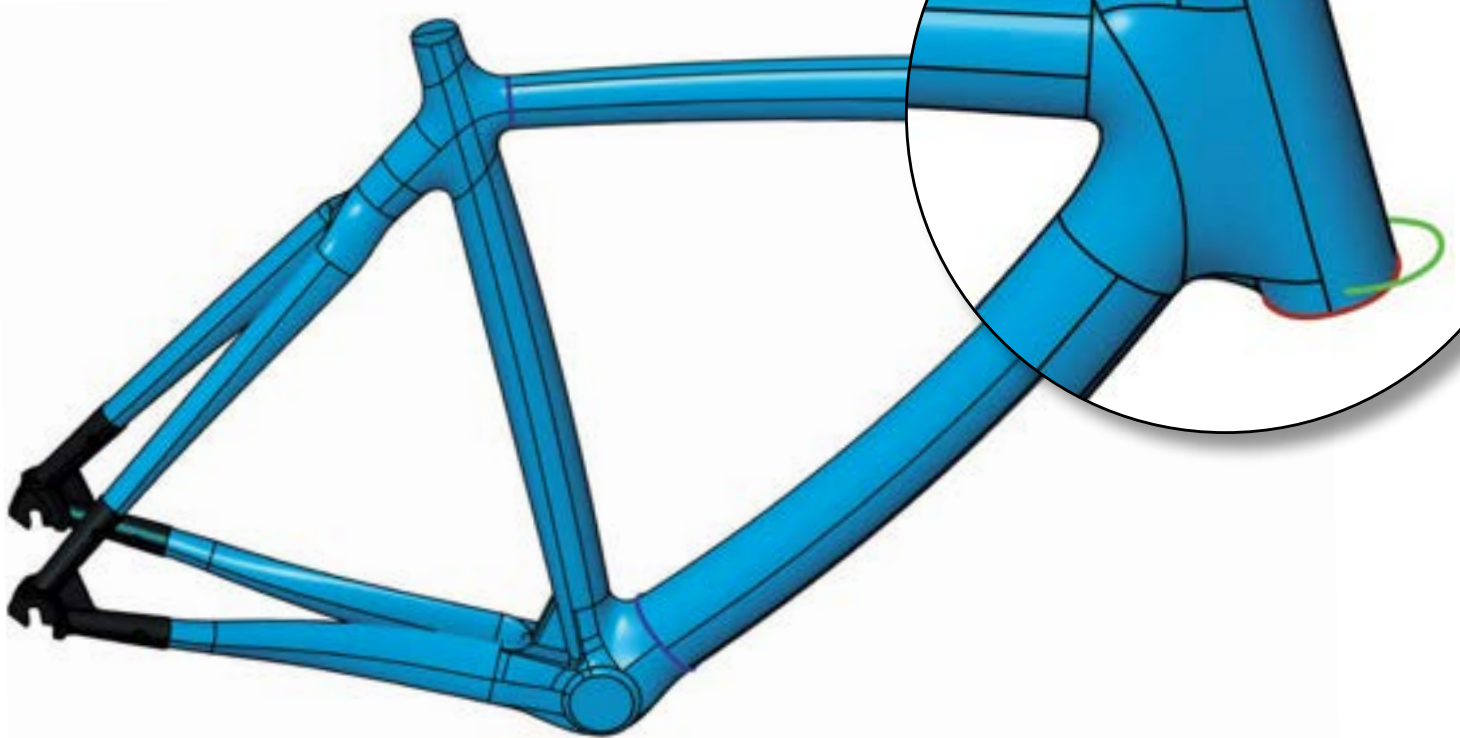

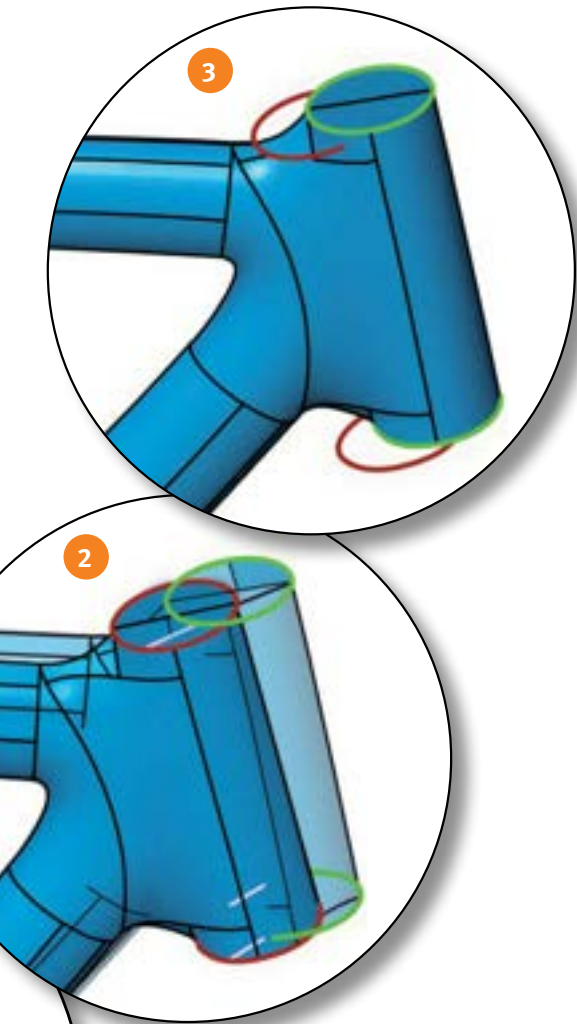

- Volumetric deformation:** Starting from an initial face, selected entities (faces, curves, points, point clouds and meshes) are deformed volumetrically to a target face.

Italian bike  
on YouTube



## Application areas

- Compensating for manufacturing variations:** Application of manufacturing variations to produce precision parts.

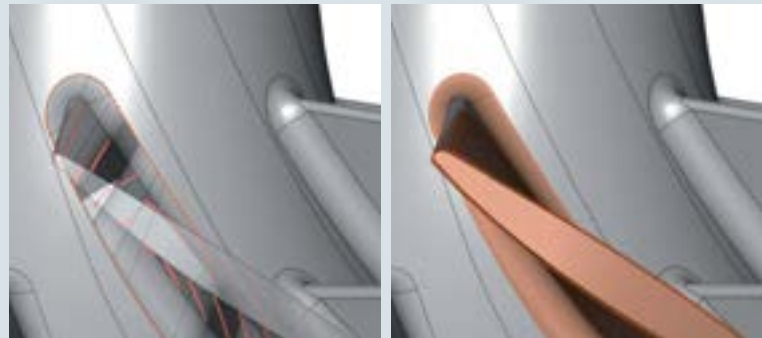
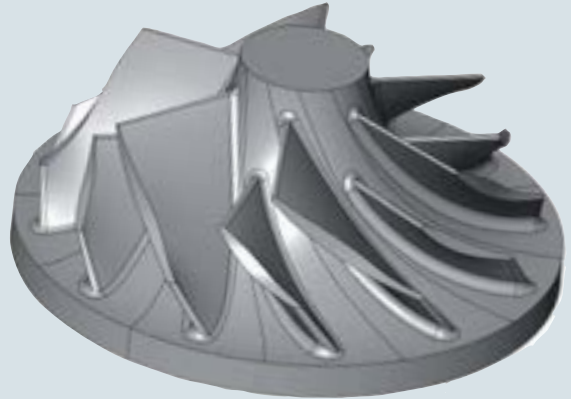

- Creating complex geometries:** Transferring a 2D logo or a tread pattern to a 3D geometry using volumetric deformation.



- Deforming entities:** Starting from start contours or points, selected entities such as faces, curves, points, point clouds and meshes (green) are deformed to target contours or points (red). Areas can also be fixed here.

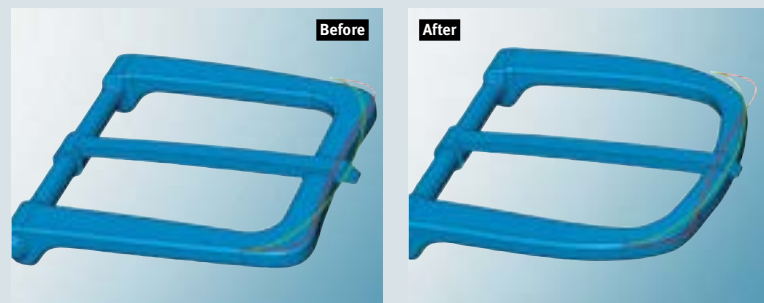



# Viewer for CAD and CAM files: more transparency, fewer errors.

*hyperCAD*<sup>®</sup>-S Viewer is available for *hyperCAD*<sup>®</sup>-S. This makes it possible to view CAD files. *hyperMILL*<sup>®</sup> SHOP Viewer is also available for *hyperCAD*<sup>®</sup>-S. This makes it possible to view CAM data from *hyperMILL*<sup>®</sup>. *hyperCAD*<sup>®</sup>-S Viewer is ideal for departments that simply want to take a brief look at their CAD data, for example, in job planning or quote calculation. *hyperCAD*<sup>®</sup>-S Viewer optionally offers all current direct interfaces and tried-and-tested neutral data formats.

*hyperMILL*<sup>®</sup> SHOP Viewer not only allows the user to view CAD data; they can also view CAM data from *hyperMILL*<sup>®</sup>. This extends the options that are available to machine operators as, until now, only the NC programs were available to them for set-ups. With *hyperMILL*<sup>®</sup> SHOP Viewer – the visualisation solution for the workshop – data that is relevant to production can be visualised and simulated directly next to the machine. Every manufacturing operation can be checked in detail on the monitor before the set-up. This results in a far better understanding of the actual manufacturing process than before and the machine operator can apply their manufacturing expertise more effectively.

**Simple and fast display,  
analysis and documentation of CAM/CAD data.**

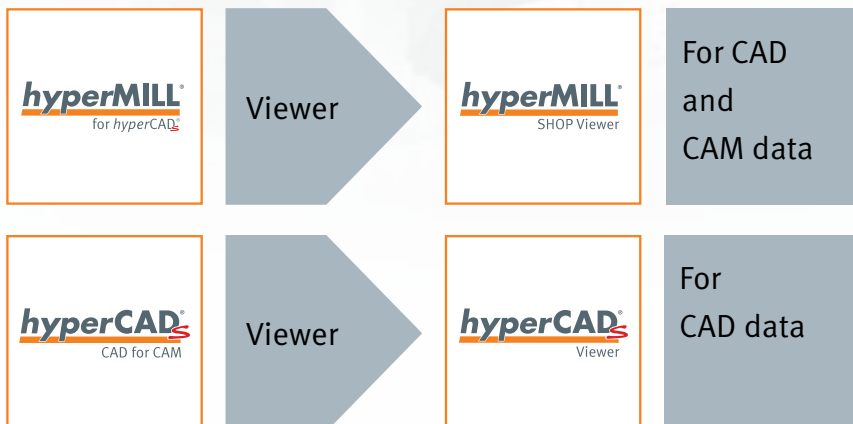



**Fast access:** *hyperCAD*<sup>®</sup>-S Viewer allows quick access to the geometry and component structure.



**Increased process reliability:** *hyperMILL*<sup>®</sup> SHOP Viewer allows experienced machine operators to recognise possible errors early on before the start of manufacturing using virtual process analyses.

## Features: *hyperCAD*<sup>®</sup>-S Viewer

- **Target groups:** The Viewer is particularly used in departments that simply want to take a brief look at their CAD data, for example, in job planning or quote calculation.
- **CAD interfaces:** The Viewer supports an extensive package of import interfaces: *hyperCAD*<sup>®</sup> files, IGES, STEP, DXF/DWG, point cloud, Parasolid<sup>®</sup> and optional Catia V4<sup>®</sup> and V5<sup>®</sup>, Autodesk<sup>®</sup> Inventor<sup>®</sup>, Siemens NX<sup>®</sup>, SOLIDWORKS, PTC<sup>®</sup> Creo.

## Features: *hyperMILL*<sup>®</sup> SHOP Viewer

- **Target group:** Machine operators can better leverage their in-depth manufacturing knowledge with *hyperMILL*<sup>®</sup> SHOP Viewer. Machining processes and parameters can be confirmed on the computer rather than adding risk to the machine tool or machined part.
- **Application area:** *hyperMILL*<sup>®</sup> SHOP Viewer is designed for quick access in the manufacturing environment during the post-CAM programming phase.
- **Simulating manufacturing processes:** The traceability of NC programs is noticeably improved through the toolpath simulation, the material removal simulation and the internal machine simulation. The manufacturing processes with the corresponding clamping status can be safely simulated starting with the stockmodel.
- **Verifying details:** Display of all elements and parameters (geometry, features and toolpaths) as in *hyperMILL*<sup>®</sup>. With a few clicks, the operator can measure and check the toolpaths on the machine, for example.
- **Improved communication:** Detailed information about *hyperMILL*<sup>®</sup> jobs are immediately and consistently available for all parties involved in the manufacturing process.
- **Fast access:** *hyperMILL*<sup>®</sup> SHOP Viewer allows quick access to all manufacturing data, as well as to the geometry and component structure.
- **Practical:** The SHOP Viewer file contains optional configuration files such as the machine model, postprocessor and POF files. This ensures that the project data is easily opened on all *hyperMILL*<sup>®</sup> SHOP Viewer workstations, without the need for any special setup.

# Electrode – Fast electrode derivation and programming

Sharp-edged and difficult-to-mill component areas are die-sunk with electrodes. The die sinking process requires suitable electrodes that need to first be constructed, then programmed and then finally milled. Without the *hyperCAD*<sup>®</sup>-S electrode module, realising this manufacturing process would take a great deal of construction and programming.

## A few short steps to constructing an electrode

The electrode module largely automates the construction process in *hyperCAD*<sup>®</sup>-S. Seamless technology and component data transfers in *hyperMILL*<sup>®</sup> also ensure fast, reliable programming. The entire process is so highly supported that programmers can carry it out with just a few clicks, without requiring any construction knowledge.

## Highlights in creating electrodes

The programmer selects the faces to be eroded on the component geometry. The module creates corresponding collision-free electrodes, which means that, when necessary, it automatically ensures extension of the electrode faces and the derivation of raw material and holders. Seamless transfer into the *hyperMILL*<sup>®</sup> CAM system is based on the geometry as well as the technological information. The programmer selects the electrodes to be programmed at this point and starts the programming using further technology definitions. If there are machining macros in place, the programming is carried out automatically.

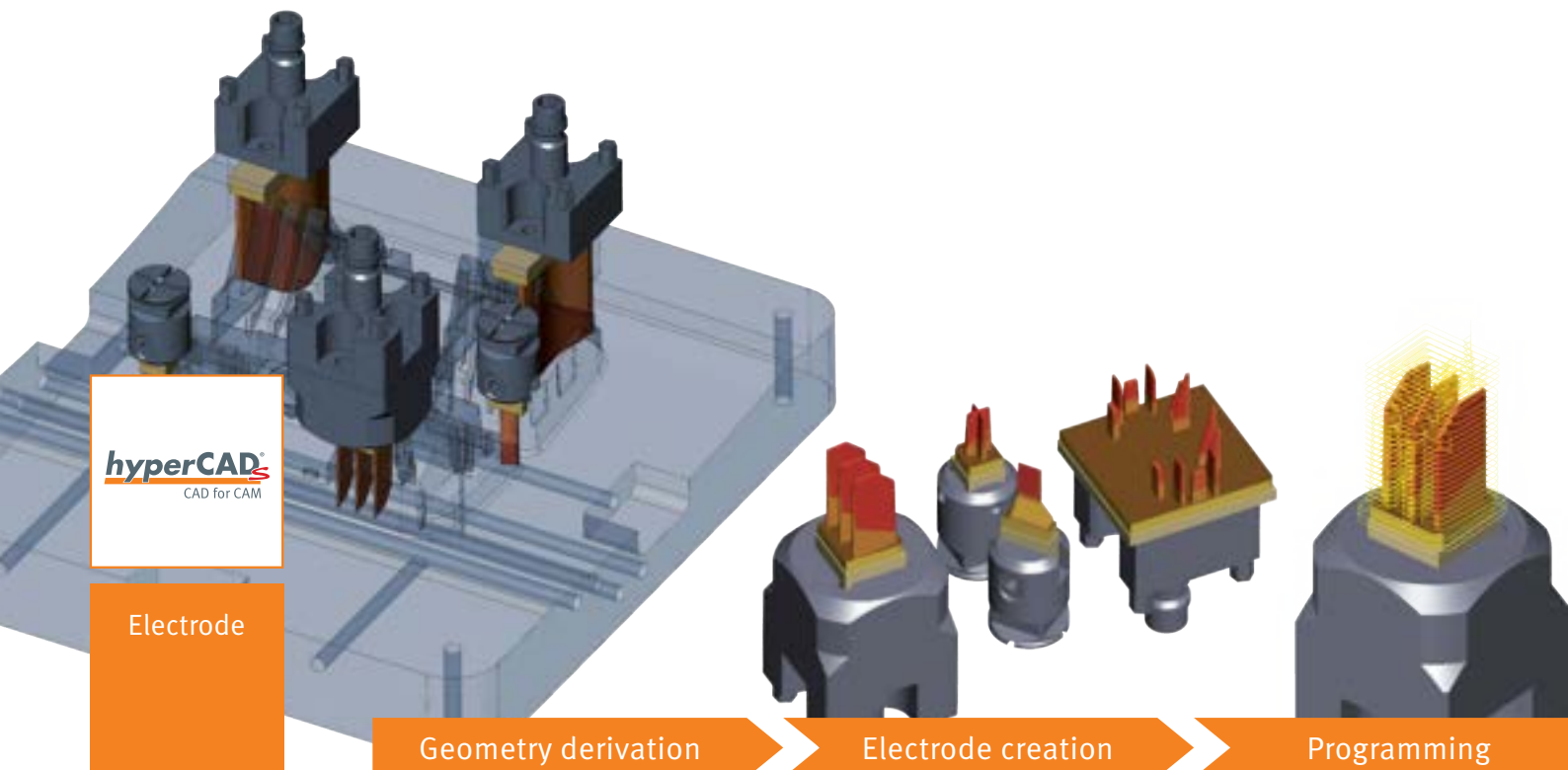



## Features

- Suitable for solid and face models
- Geometry selection through face and contour selection
- Automatic extension of electrode geometry
- Holes in the geometry can be automatically closed
- Measuring markers for the electrode
- Automatic colour and layer definition for the individual electrode areas
- Automatic raw material and holder selection with best fit option for optimal alignment
- Automatic stock calculation and collision avoidance
- Electrode reference as chamfer or radius
- Detailed reports
- Incorporation of manually created electrode geometries into the automated process
- Automatic calculation of the minimum rib distance
- Automatic calculation of the length and adjustment options for the length of useless raw material
- Fast programming in *hyperMILL*®:  
All technology data, such as the spark gap, stock size and positional reference, are automatically transferred in *hyperMILL*®. The programming work can even be further automated using machining macros.

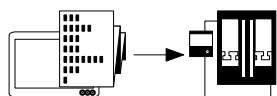

Milling program

EDM

## Electrode module functions:

### ■ Colour coding

User-specific colour information is automatically applied to the geometry areas of the electrode.

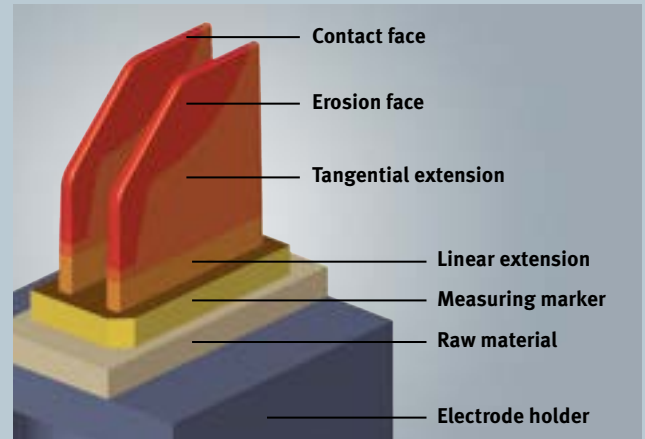

### ■ Geometry extension

Automatic tangential or linear extension of the electrode geometry. Angle extension is also available for stabilisation.

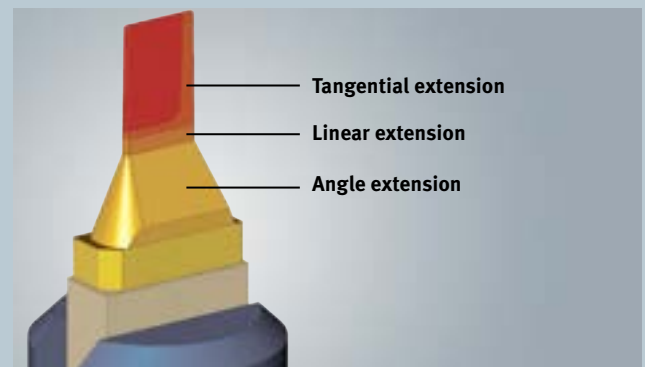

### ■ Production report

A print view with technological information or electrode and raw material reports can be issued for each individual electrode.

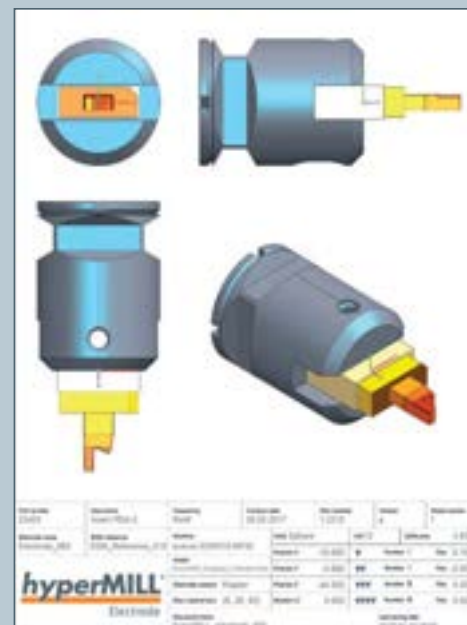

- Headquarters** OPEN MIND Technologies AG  
Argelsrieder Feld 5 • 82234 Wessling • Germany  
Phone: +49 8153 933-500  
E-mail: Info.Europe@openmind-tech.com  
Support.Europe@openmind-tech.com
- UK** OPEN MIND Technologies UK Ltd.  
Units 1 and 2 • Bicester Business Park  
Telford Road • Bicester • Oxfordshire OX26 4LN • UK  
Phone: +44 1869 290003  
E-mail: Info.UK@openmind-tech.com
- USA** OPEN MIND Technologies USA, Inc.  
1492 Highland Avenue, Unit 3 • Needham MA 02492 • USA  
Phone: +1 888 516-1232  
E-mail: Info.Americas@openmind-tech.com
- Brazil** OPEN MIND Tecnologia Brasil LTDA  
Av. Andromeda, 885 SL2021  
06473-000 • Alphaville Empresarial  
Barueri • Sao Paulo • Brasil  
Phone: +55 11 2424 8580  
E-mail: Info.Brazil@openmind-tech.com
- Asia Pacific** OPEN MIND Technologies Asia Pacific Pte. Ltd.  
33 Ubi Avenue 3 #06-32 • Vertex (Tower B)  
Singapore 408868 • Singapore  
Phone: +65 6742 95-56  
E-mail: Info.Asia@openmind-tech.com
- China** OPEN MIND Technologies China Co. Ltd.  
Suite 1608 • Zhong Rong International Plaza  
No. 1088 South Pudong Road  
Shanghai 200120 • China  
Phone: +86 21 588765-72  
E-mail: Info.China@openmind-tech.com
- India** OPEN MIND CAD/CAM Technologies India Pvt. Ltd.  
3C-201, 2<sup>nd</sup> Floor • 2<sup>nd</sup> Main Road • Kasturi Nagar  
Bangalore 560 043 • Karnataka • India  
Phone: +91 80 3232 4647  
E-mail: Info.India@openmind-tech.com
- Japan** OPEN MIND Technologies Japan K.K.  
Misumi Bldg. 3F • 1-17-18, Kichijojihigashicho  
Musashino-shi • Tokyo 180-0002 • Japan  
Phone: +81 422 23-5305  
E-mail: info.jp@openmind-tech.co.jp
- Taiwan** OPEN MIND Technologies Taiwan Inc.  
3F., No.153, Huanbei Rd., Zhongli Dist. • Taoyuan City 32055  
Taiwan (R.O.C.)  
Phone: +886 3 46131-25  
E-mail: Info.Taiwan@openmind-tech.com

OPEN MIND Technologies AG is represented worldwide with own subsidiaries and through competent partners and is a member of the Mensch und Maschine technology group, [www.mum.de](http://www.mum.de)

[www.openmind-tech.com](http://www.openmind-tech.com)



We push machining to the limit