

# *hyperMILL*<sup>®</sup>

for SOLIDWORKS

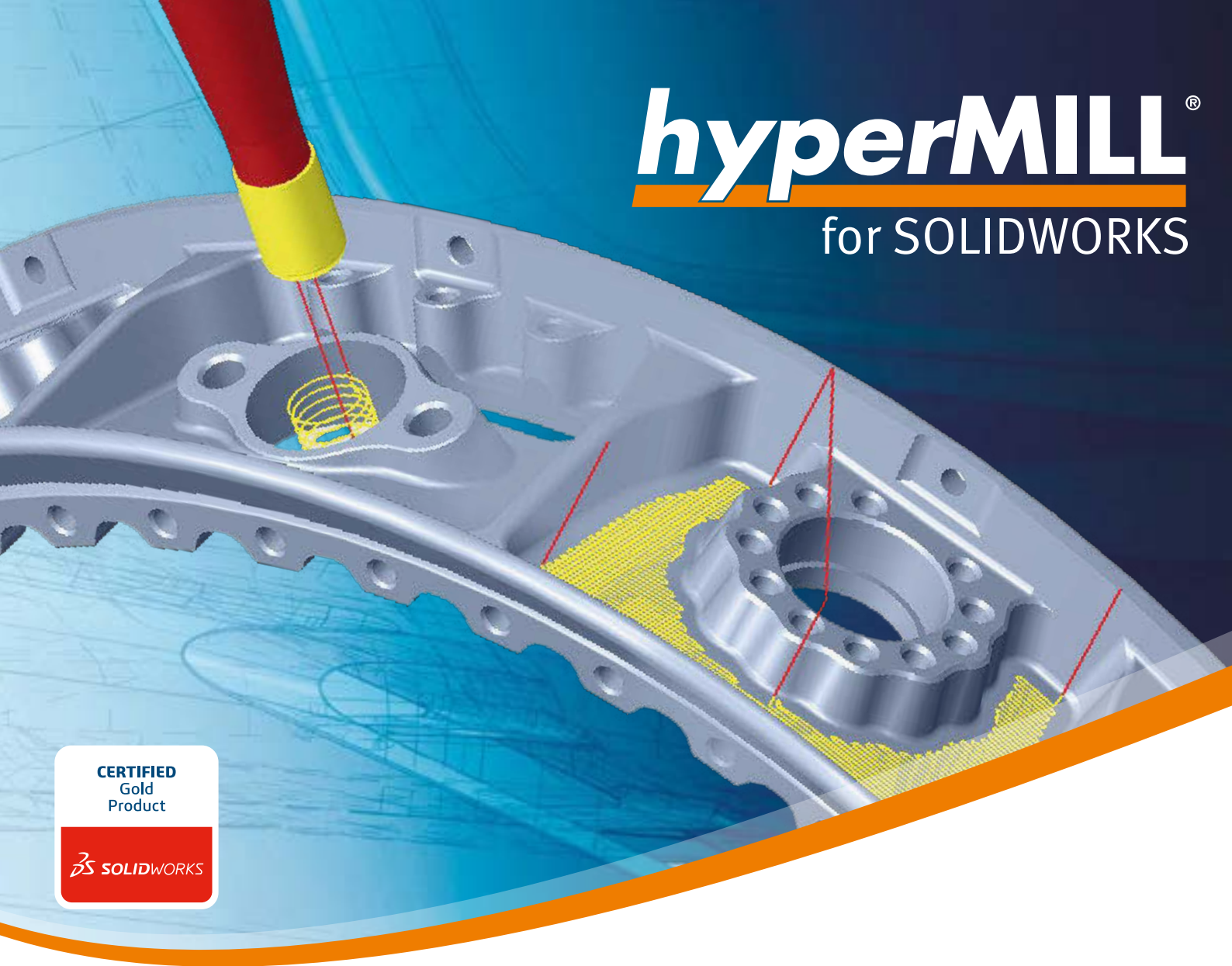

CERTIFIED  
Gold  
Product

 SOLIDWORKS

*hyperMILL*<sup>®</sup>  
for SOLIDWORKS

CAD-INTEGRATION

 **OPEN MIND**  
THE CAM FORCE

# Efficient and reliable machining

*hyperMILL*® is one of the world's most powerful CAM solutions for machine- and controller-independent programming. The system provides extremely innovative, flexible and powerful CAM strategies that allow manufacturers to achieve quality, time and cost targets much more quickly, even on challenging parts.

Surfaces and edges are visibly smoother, cleaner and more precise. This is high-precision machining in a nutshell. Even hard-to-reach areas can be machined safely thanks to the reliable collision avoidance function. *hyperMILL*® gives users the security of knowing that they can manufacture new components quickly and flexibly.

## Seven reasons to choose *hyperMILL*®:

- 1 Future-proof investment
- 2 Top performance
- 3 Easy to use
- 4 Efficient and reliable processes
- 5 Optimised workflow
- 6 Superb quality
- 7 Everything can be automated



2,5D

3D

5axis

Mill turning

Measuring

# Increased performance

**Speed is more crucial than ever these days.**

***hyperMILL*® MAXX Machining allows you to significantly reduce machining times.**

The *hyperMILL*® MAXX Machining performance package comprises three separate modules for highly efficient roughing, finishing and drilling. Trochoidal toolpaths ensure extremely fast material removal. Innovative strategies for barrel cutters, also known as circle segment end mills, allow extremely fast finishing with equivalent or significantly higher surface qualities. Milling tools tilted in the cutting direction can drill holes quickly and easily, even in materials that are difficult to machine and without the need for a predrilled hole.

## **More safety during machining**

Better safe than sorry! This is what the fully automatic collision checking and avoidance are for. *hyperMILL*® detects collisions and provides powerful solutions for avoiding collisions during 2.5D, 3D and 5axis machining. A collision-free tool angle is calculated automatically for 5axis simultaneous machining. The user can decide which axis of rotation should be prioritised in collision avoidance depending on the machine kinematics.

“We look for and find unique strategies for efficient machining.”

Dr. Josef Koch, CTO of OPEN MIND Technologies AG

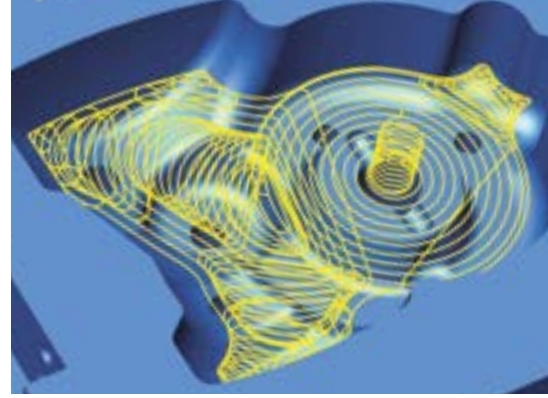

HPC roughing

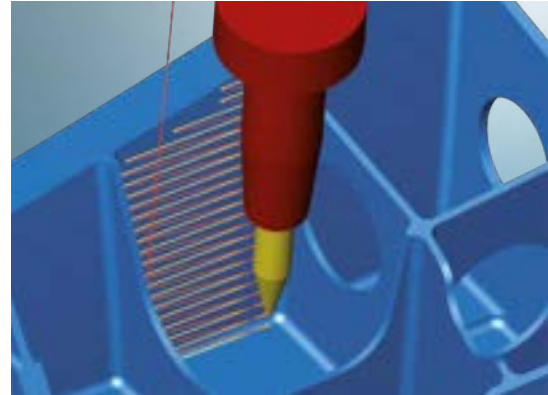

Performance finishing

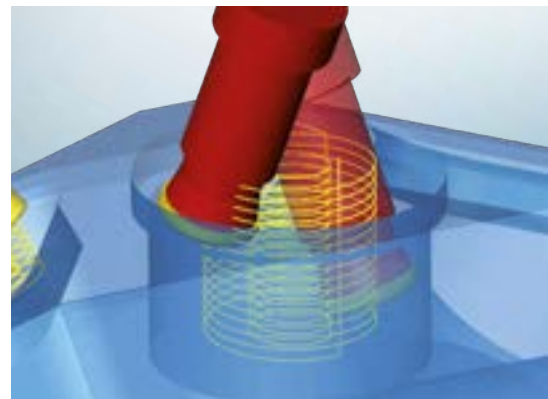

Performance drilling

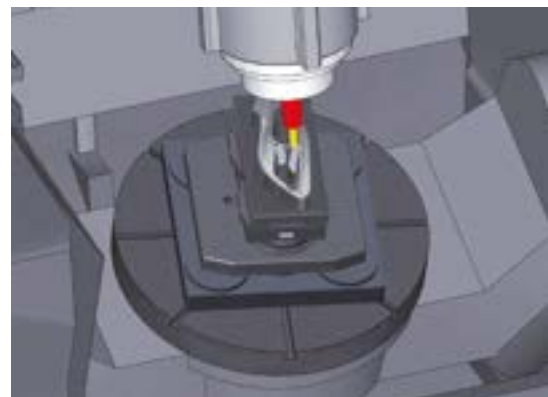

Machine simulation



# Powerful CAM strategies

## 2.5D machining

*hyperMILL*® 2.5D machining is typically used for plate processing in tool and mould manufacturing where there are numerous pockets, plane levels, contours and drill holes. Intelligent mechanisms – that detect pocket and drill features, for example – speed up programming even further.

## 3D machining

*hyperMILL*® offers powerful and precise functions for 3D milling. It allows users to manufacture high-quality surfaces quickly and reliably, even with complex workpieces. Numerous strategies for roughing and finishing ensure efficient 3D machining.

## 5AXIS machining

5axis machining from *hyperMILL*® is ideal for working with challenging geometries, free-form surfaces and deep cavities. It is significantly more efficient than 3axis technology. *hyperMILL*® offers a wide range of powerful 5axis strategies for simultaneous and indexed roughing and finishing, which allows users to produce top-quality surfaces.

## 5AXIS special applications

Mit den Paketen für das Bearbeiten von Impellern und Blisks, With packages for machining impellers, blisks, turbine blades, tubes and tire moulds, *hyperMILL*® offers solutions for the complete machining of complex part geometries. Intelligent automated functions, optimised milling strategies and a simple workflow allow even users without special expertise to reliably and effectively program cycles.

## Mill turning

A single CAM solution allows easy programming of milling and turning cycles in one setup on the mill/turn machine. Mill turning is completely integrated into *hyperMILL*®. This allows the tool data-base, stock tracking, collision checking and postprocessors to be used jointly for all milling and turning operations.

## Measuring

Internal process quality control on the CNC machine tool is becoming increasingly important. This is why *hyperMILL*® also features measurement cycles that provide the necessary in-process measurement data.

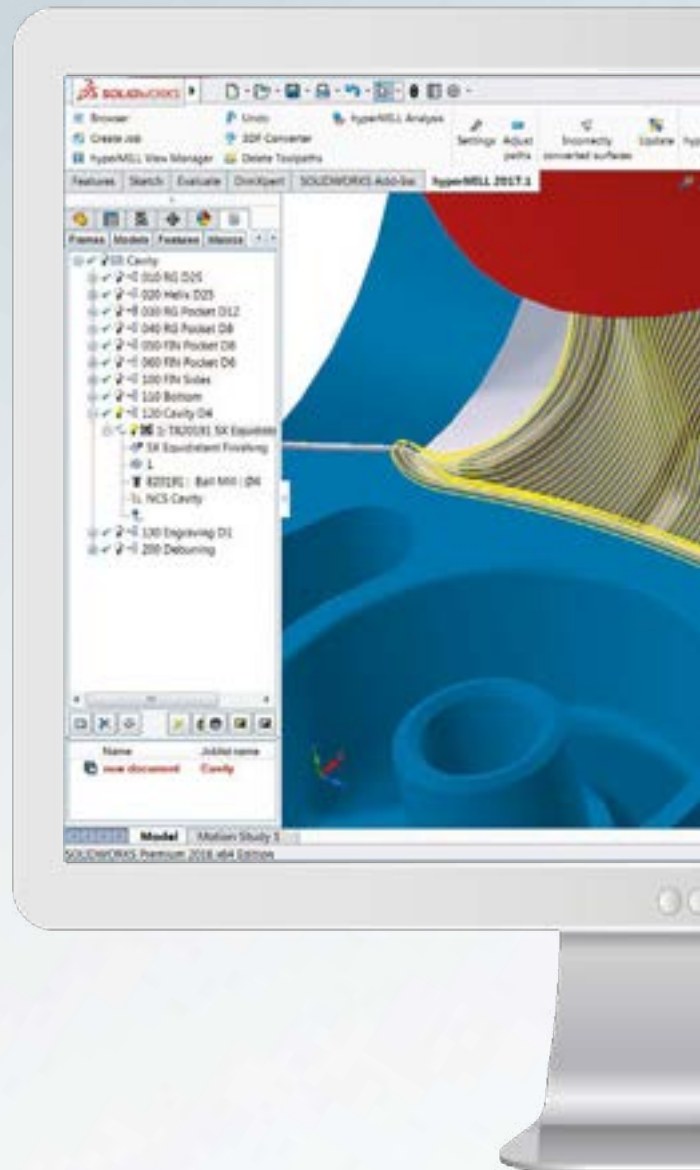

**TRAINING**  
Comprehensive  
training concept

# hyperMILL®

for SOLIDWORKS

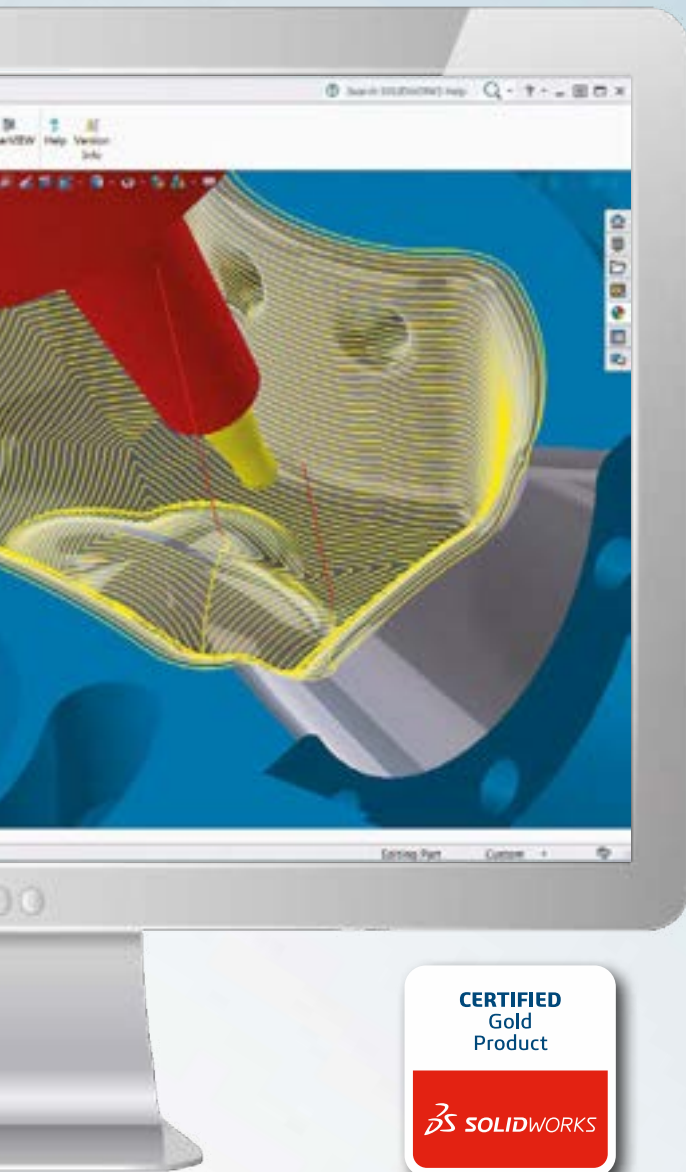

## Safer processes

### Single database

Integration facilitates continuous processes thanks to a unified database. Both the CAD and CAM systems use the same data model.

### Programming

Numerous machining strategies are available in a single user interface for the user to quickly and reliably program CAM cycles. Users do not need to switch between two or more programs, which in turn simplifies operation, offers more ease of use and ensures the highest programming reliability possible.

### Automating

Users can automatically program drill holes, pockets, variants and part families right away using the sophisticated feature and macro technology. The automation technology from OPEN MIND is one of the most advanced in the world and fulfils all requirements. Our experts can create tailored solutions – to fully automate processes or connect a process to an API interface, for example.

### Simulating

The precise machine and material removal simulation allows users to quickly and dynamically check tool movements. The machine simulation feature in *hyperMILL*® allows users to verify that processes are safe before the final NC program is created. In addition, *hyperMILL*® VIRTUAL Machining Center allows users to create a simulation that is based on the NC code. The collision check takes place after each post-processor run – that is, directly in the generated NC program – ensuring maximum process safety.

### Machining

High performing part programs and optimised postprocessors mean that *hyperMILL*® ensures safe manufacturing processes. Thanks to reliable collision checking and avoidance, the 5axis machining of complex components is just as reliable as the machining of 3D tasks.

### Managing

It is necessary today for process and component data to be managed centrally. *hyperMILL*® fulfils this requirement by providing interfaces for leading product lifecycle management systems: ENOVIA, Teamcenter and Windchill.

**CONSULTING**  
Individual  
consultation from  
experts

**SUPPORT**  
Expert technicians  
worldwide

# At home in all sectors

## *hyperMILL*<sup>®</sup> for SOLIDWORKS – the complete system for efficient and reliable CAM programming

Whether you work with simple or highly complex components, *hyperMILL*<sup>®</sup> allows you to significantly reduce your programming and machining times. The results fulfil our customers' most demanding requirements on precision, reliability, surface quality and machining time.

### **Unique CAM strategies that are easy to operate**

*hyperMILL*<sup>®</sup> is a modular and flexible CAM solution for 2.5D, 3D and 5axis milling as well as mill turning and machining operations such as high-speed cutting (HSC) and high-performance cutting (HPC). The special applications for milling impellers, blisks, turbine blades, tubes and tires round off the range of functions available in *hyperMILL*<sup>®</sup>.

### **Optimised postprocessors**

Powerful right up to program output. We consider postprocessor technology to be one of our core competencies. That's why we develop all postprocessors and perfectly tailor them to the machines.

WE PUSH MACHINING TO THE LIMIT.

### **Global success**

Our customers come from all around the world and from a range of sectors, including engineering, tooling, prototyping and mould manufacturing as well as the motor sports, aerospace, energy, medical industries, and watches and jewellery sectors, to name but a few. Users appreciate the significant cost savings and increases in efficiency in addition to the excellent machining results.



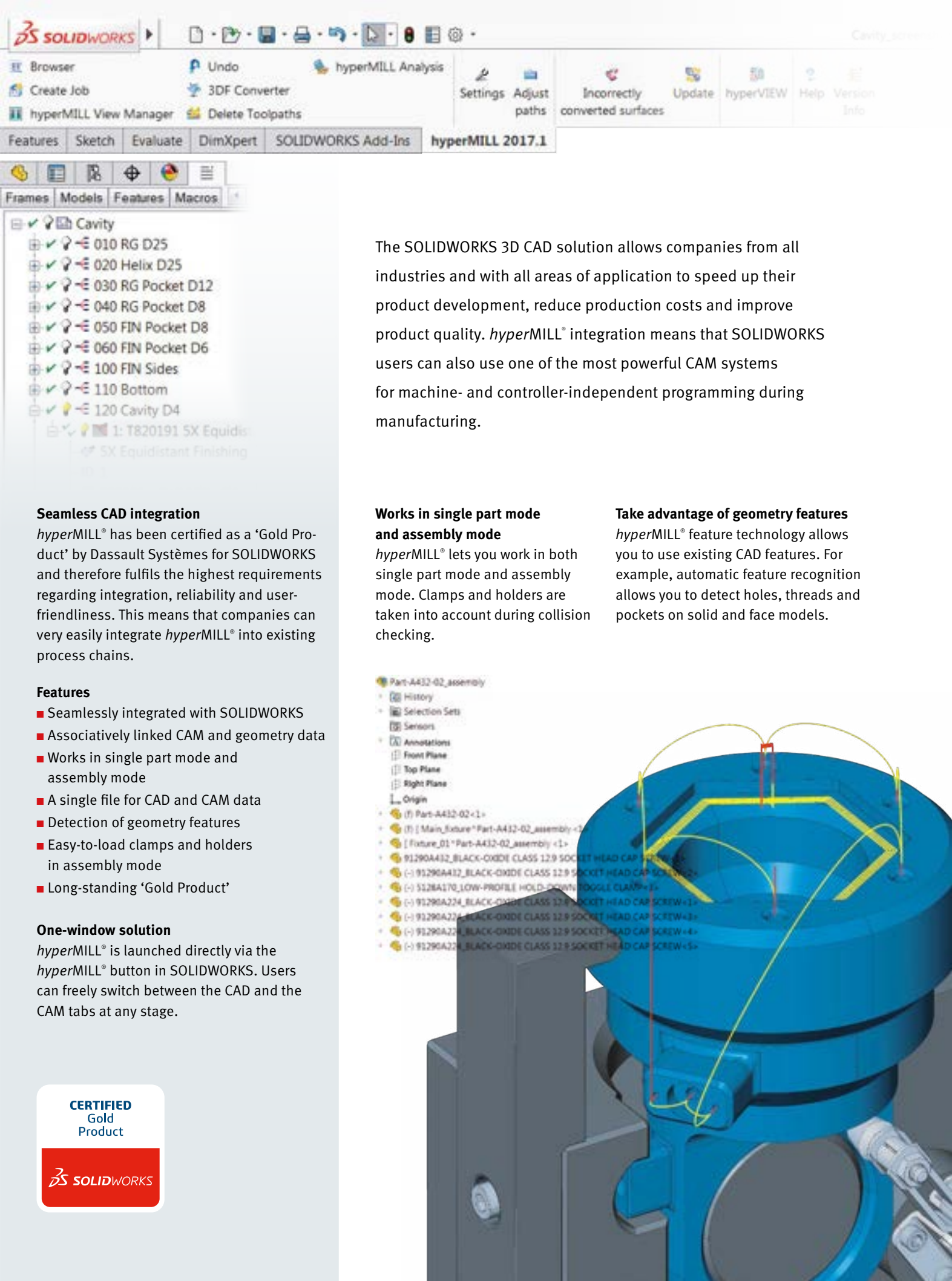

The SOLIDWORKS 3D CAD solution allows companies from all industries and with all areas of application to speed up their product development, reduce production costs and improve product quality. *hyperMILL*® integration means that SOLIDWORKS users can also use one of the most powerful CAM systems for machine- and controller-independent programming during manufacturing.

**Seamless CAD integration**

*hyperMILL*® has been certified as a ‘Gold Product’ by Dassault Systèmes for SOLIDWORKS and therefore fulfils the highest requirements regarding integration, reliability and user-friendliness. This means that companies can very easily integrate *hyperMILL*® into existing process chains.

**Features**

- Seamlessly integrated with SOLIDWORKS
- Associatively linked CAM and geometry data
- Works in single part mode and assembly mode
- A single file for CAD and CAM data
- Detection of geometry features
- Easy-to-load clamps and holders in assembly mode
- Long-standing ‘Gold Product’

**One-window solution**

*hyperMILL*® is launched directly via the *hyperMILL*® button in SOLIDWORKS. Users can freely switch between the CAD and the CAM tabs at any stage.

**Works in single part mode and assembly mode**

*hyperMILL*® lets you work in both single part mode and assembly mode. Clamps and holders are taken into account during collision checking.

**Take advantage of geometry features**

*hyperMILL*® feature technology allows you to use existing CAD features. For example, automatic feature recognition allows you to detect holes, threads and pockets on solid and face models.

- Part-A432-02\_assembly
  - History
  - Selection Sets
  - Sensors
  - Annotations
    - Front Plane
    - Top Plane
    - Right Plane
    - Origin
  - (1) Part-A432-02<1>
  - (1) [ Main Fixture ] Part-A432-02\_assembly<1>
  - [ Fixture\_01 ] Part-A432-02\_assembly<1>
  - 91290A432\_BLACK-OXIDE CLASS 12.9 SOCKET HEAD CAP SCREW<1>
  - (-) 91290A432\_BLACK-OXIDE CLASS 12.9 SOCKET HEAD CAP SCREW<2>
  - (-) 3128A170\_LOW-PROFILE HOLD-DOWNS TOGGLE CLASS<1>
  - (-) 91290A224\_BLACK-OXIDE CLASS 12.9 SOCKET HEAD CAP SCREW<1>
  - (-) 91290A224\_BLACK-OXIDE CLASS 12.9 SOCKET HEAD CAP SCREW<3>
  - (-) 91290A224\_BLACK-OXIDE CLASS 12.9 SOCKET HEAD CAP SCREW<4>
  - (-) 91290A224\_BLACK-OXIDE CLASS 12.9 SOCKET HEAD CAP SCREW<5>

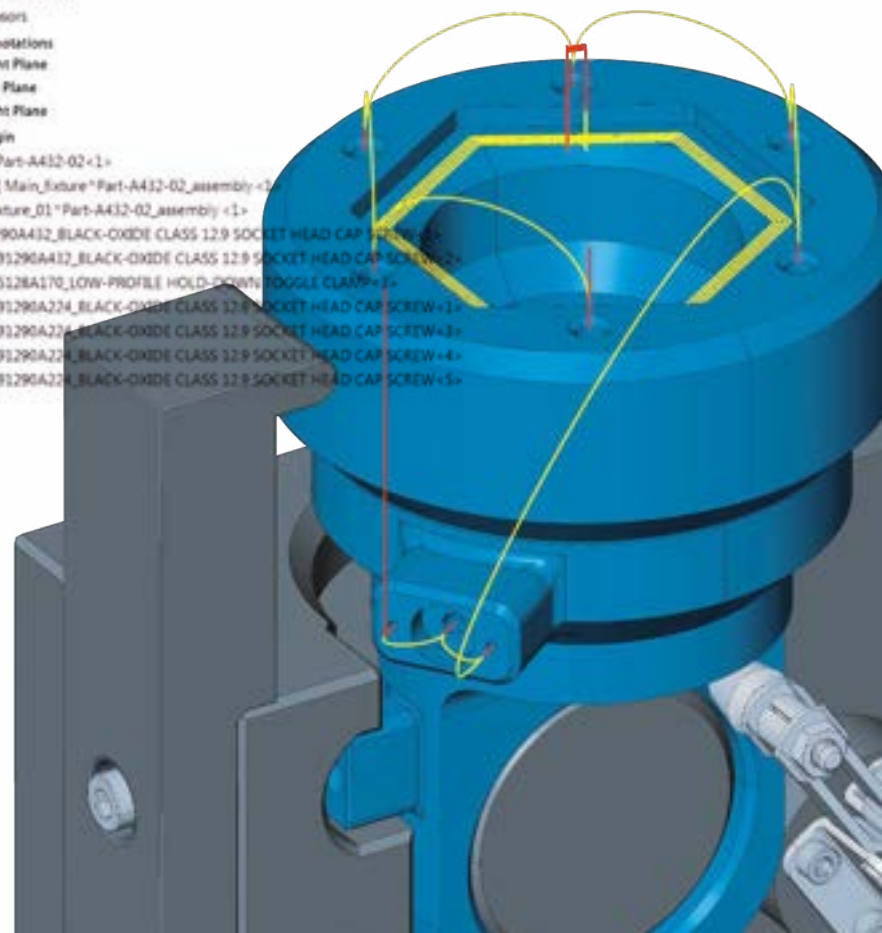

**HEADQUARTERS**

**OPEN MIND Technologies AG**  
Argelsrieder Feld 5 • 82234 Wessling • Germany  
Phone: +49 8153 933-500  
E-mail: [Info.Europe@openmind-tech.com](mailto:Info.Europe@openmind-tech.com)  
[Support.Europe@openmind-tech.com](mailto:Support.Europe@openmind-tech.com)

**SWEDEN**

**OPEN MIND Technologies Scandinavia AB**  
Älvhålegatan 34  
417 28 Gothenburg  
E-mail: [Info.Scandinavia@openmind-tech.com](mailto:Info.Scandinavia@openmind-tech.com)

**UK**

**OPEN MIND Technologies UK Ltd.**  
Unit 3 • Bicester Business Park  
Telford Road • Bicester • Oxfordshire OX26 4LN • UK  
Phone: +44 1869 290003  
E-mail: [Info.UK@openmind-tech.com](mailto:Info.UK@openmind-tech.com)

**USA**

**OPEN MIND Technologies USA, Inc.**  
1492 Highland Avenue, Unit 3 • Needham MA 02492 • USA  
Phone: +1 888 516-1232  
E-mail: [Info.Americas@openmind-tech.com](mailto:Info.Americas@openmind-tech.com)

**BRAZIL**

**OPEN MIND Tecnologia Brasil LTDA**  
Av. Andromeda, 885 SL2021  
06473-000 • Alphaville Empresarial  
Barueri • Sao Paulo • Brasil  
Phone: +55 11 2424 8580  
E-mail: [Info.Brazil@openmind-tech.com](mailto:Info.Brazil@openmind-tech.com)

**ASIA PACIFIC**

**OPEN MIND Technologies Asia Pacific Pte. Ltd.**  
3791, Jalan Bukit Merah • #04-08  
Singapore 159471 • Singapore  
Phone: +65 6742 95-56  
E-mail: [Info.Asia@openmind-tech.com](mailto:Info.Asia@openmind-tech.com)

**CHINA**

**OPEN MIND Software Technologies China Co., Ltd.**  
Suite 1608 • Zhong Rong International Plaza  
No. 1088 South Pudong Road  
Shanghai 200120 • China  
Phone: +86 21 588765-72  
E-mail: [Info.China@openmind-tech.com](mailto:Info.China@openmind-tech.com)

**INDIA**

**OPEN MIND CAD/CAM Technologies India Pvt. Ltd.**  
No. 610 and 611 • 6<sup>th</sup> Floor • 'B' Wing  
No. 6, Mittal Tower, M.G. Road  
Bangalore 560001 • Karnataka • India  
Phone: +91 80 2676 6999  
E-mail: [Info.India@openmind-tech.com](mailto:Info.India@openmind-tech.com)

**JAPAN**

**OPEN MIND Technologies Japan K.K.**  
Albergo Musashino B101, 3-2-1 Nishikubo  
Musashino-shi • Tokyo 180-0013 • Japan  
Phone: +81-50-5370-1018  
E-mail: [Info.Japan@openmind-tech.com](mailto:Info.Japan@openmind-tech.com)

**TAIWAN**

**OPEN MIND Technologies Taiwan Inc.**  
Rm. F, 4F., No.1, Yuandong Rd., Banqiao Dist.  
New Taipei City 22063 • Taiwan  
Phone: +886 2 2957-6898  
E-mail: [Info.Taiwan@openmind-tech.com](mailto:Info.Taiwan@openmind-tech.com)

OPEN MIND Technologies AG is represented worldwide with own subsidiaries and through competent partners and is a member of the Mensch und Maschine technology group, [www.mum.de](http://www.mum.de)



We push machining to the limit

[www.openmind-tech.com](http://www.openmind-tech.com)