



# SHINING 3D



## EXScan H

V 1.2.0

# User Manual

# Table of Contents

## Overview

### Welcome

- Safety instructions
- About the document

### Device

- Appearance
  - Scanner
  - Component
- Connect the cable

### Installation

- Computer & Operating system requirement
  - CPU
  - OpenGL
  - GPU
- Get the installation package
- Install the software

### Activation

- Register for Shining 3D User Account
- Login
- Activate the device
  - Online activation
  - Offline activation

### Upgrade

- Firmware upgrade
- Software upgrade

### Interface

- Navigation bar
- Settings and feedback
  - Social
  - Settings
  - Help
- Other components

## Quick guide

### Calibration

- Standard calibration

- White balance
- Quick calibration

## Scan

### Workflow

#### Preparation

- Preparation for portrait scan
  - Hair
- Preparation for different object

#### Scan mode

- White light mode
- IR mode

#### Project and project group

- Project group
  - Create project group
  - Open project group
- Project

#### Project setting

- Alignment
- Resolution
- Texture
- Alignment
- Resolution
- Texture

## Scanning

### Scan setting

- Brightness
- Working distance
- Other function

### Scanning

- Preview / Scan / Pause
- Generate point clouds

### Scan data edit

- Cutting plane
  - Create cutting plane
  - Set cutting plane

### Scan functions

### Align point cloud

## Post Processing

### **Mesh**

- Mesh type
- Mesh optimization

### **Mesh editing**

- Left panel
- Bottom panel
- Right panel

## Measurement

### **Create Features**



### **Movement**

### **Measurement**

# Overview

# Welcome

## Safety instructions

| Symbol                                                                            | Description                                                                                                                                                                                     |
|-----------------------------------------------------------------------------------|-------------------------------------------------------------------------------------------------------------------------------------------------------------------------------------------------|
|  | <b>NOTE:</b> This symbol is used to inform you of the additional information of the product.                                                                                                    |
|  | <b>CAUTION:</b> This symbol is used to inform you of incorrect operations that may damage the device or result in data loss. Any damages resulting from misuse are not covered by the warranty. |
|  | <b>DANGER:</b> This symbol is used to inform you of the potential risks that may result in serious personal injury and other safety incidents.                                                  |

## About the document

This document is related to your safety, lawful rights and responsibilities. Read it carefully before installing and using the product.

- SHINING 3D Tech Co., Ltd. (hereinafter referred to as “the Company”) owns complete intellectual property rights for the contents of this document and, without the written consent of the Company, it is not allowed to copy, transmit, publish, reedit, compile or translate any contents of this document for any purpose or in any form.
- The document is a guidance for installing, operating, and maintaining the product, including the Device, software, or other products provided by the Company, to which the document is applicable. The document does not serve as the quality guaranty for the product. While the Company makes all efforts to ensure the applicability of the content of the document, it reserves the right to interpret and modify the content of the document and possible errors and omissions therein. The contents of the document are subject to changes without further notice.
- Images and diagrams in the document are presented to provide convenience to readers. In the event that any images or diagrams are inconsistent with the physical product, the later shall prevail.
- It is recommended that professionals or technicians shall operate and/or use relevant Products. The Company shall not be held responsible for any damages and/or losses caused by negligence, environmental factors, or improper maintenance and use, or any other factors other than due to the quality of the Product.
- Disputes arising from the document and related Products thereof shall be governed by the laws of the People’s Republic of China.
- In the event of any ambiguity and/or any advice on the contents of the document, contact us by the contact

For more information, please visit our support website: [support.einscan.com \(https://support.einscan.com/\)](https://support.einscan.com/)

# Device

Please read carefully before the first time of using EinScan H2 (hereinafter referred to as the "Scanner").

## Appearance

### Scanner



| Appearance | Description                |
|------------|----------------------------|
| 1          | Working distance indicator |
| 2          | Zoom in / Zoom out         |
| 3          | Brighter / Darker          |
| 4          | Preview / Scan / Pause     |
| 5          | USB port                   |
| 6          | Power port                 |



# Component

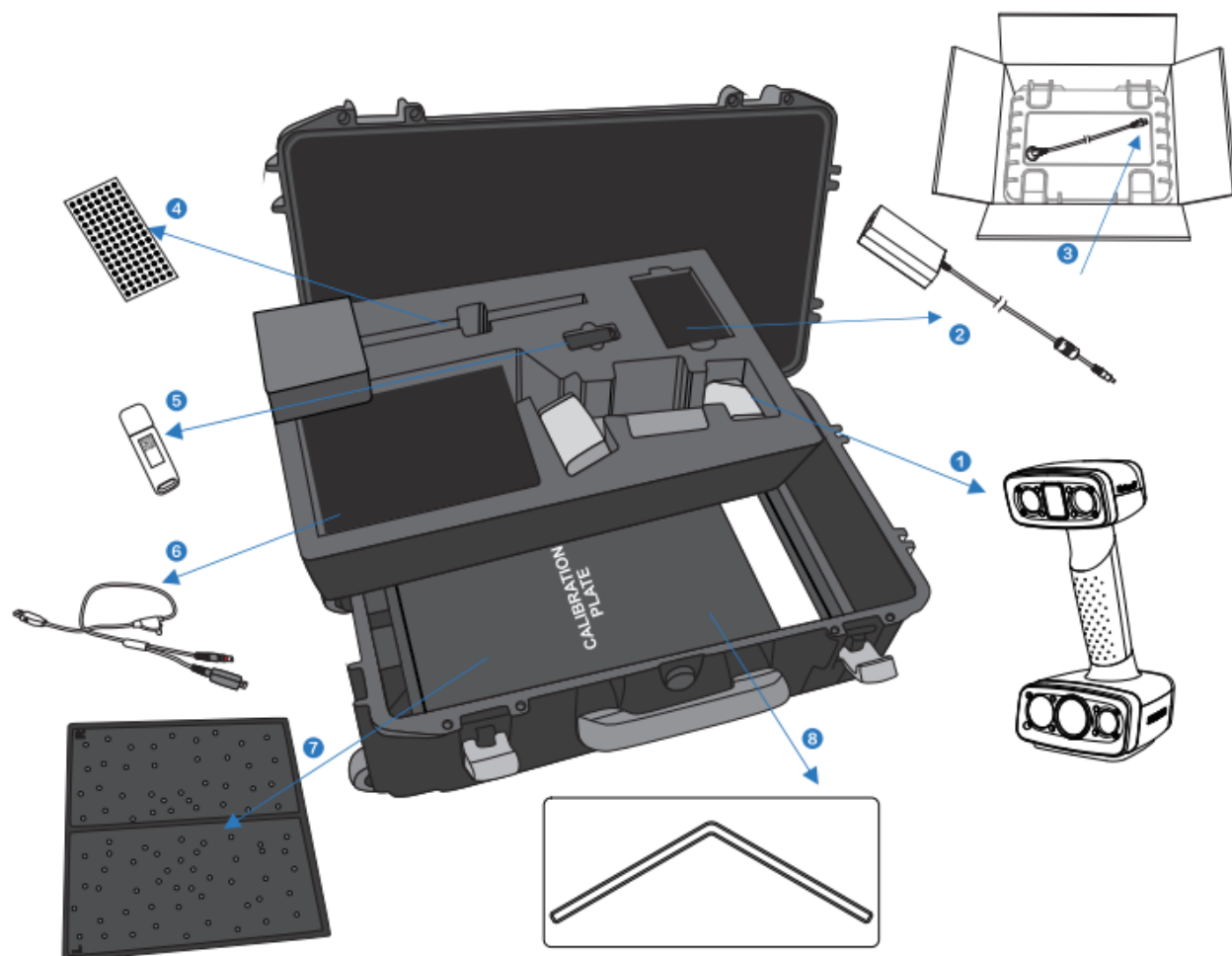

- |                 |                                         |
|-----------------|-----------------------------------------|
| 1 Scanner       | 5 USB drive                             |
| 2 Power adapter | 6 Data cable and power cord(USB, DC IN) |
| 3 Power cord    | 7 Calibration board                     |
| 4 Markers       | 8 Calibration pad                       |

## Connect the cable

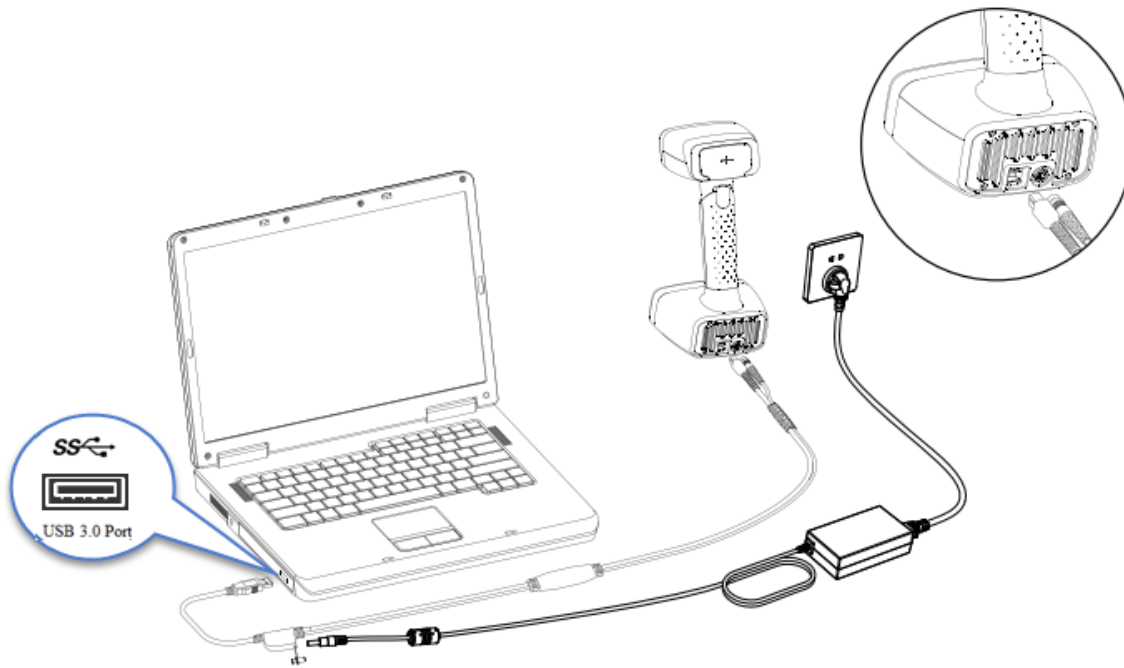

### Warning

Make sure you are using the correct power adapter.

### Steps

1. Plug *USB* and *DC IN* into the bottom of Scanner.

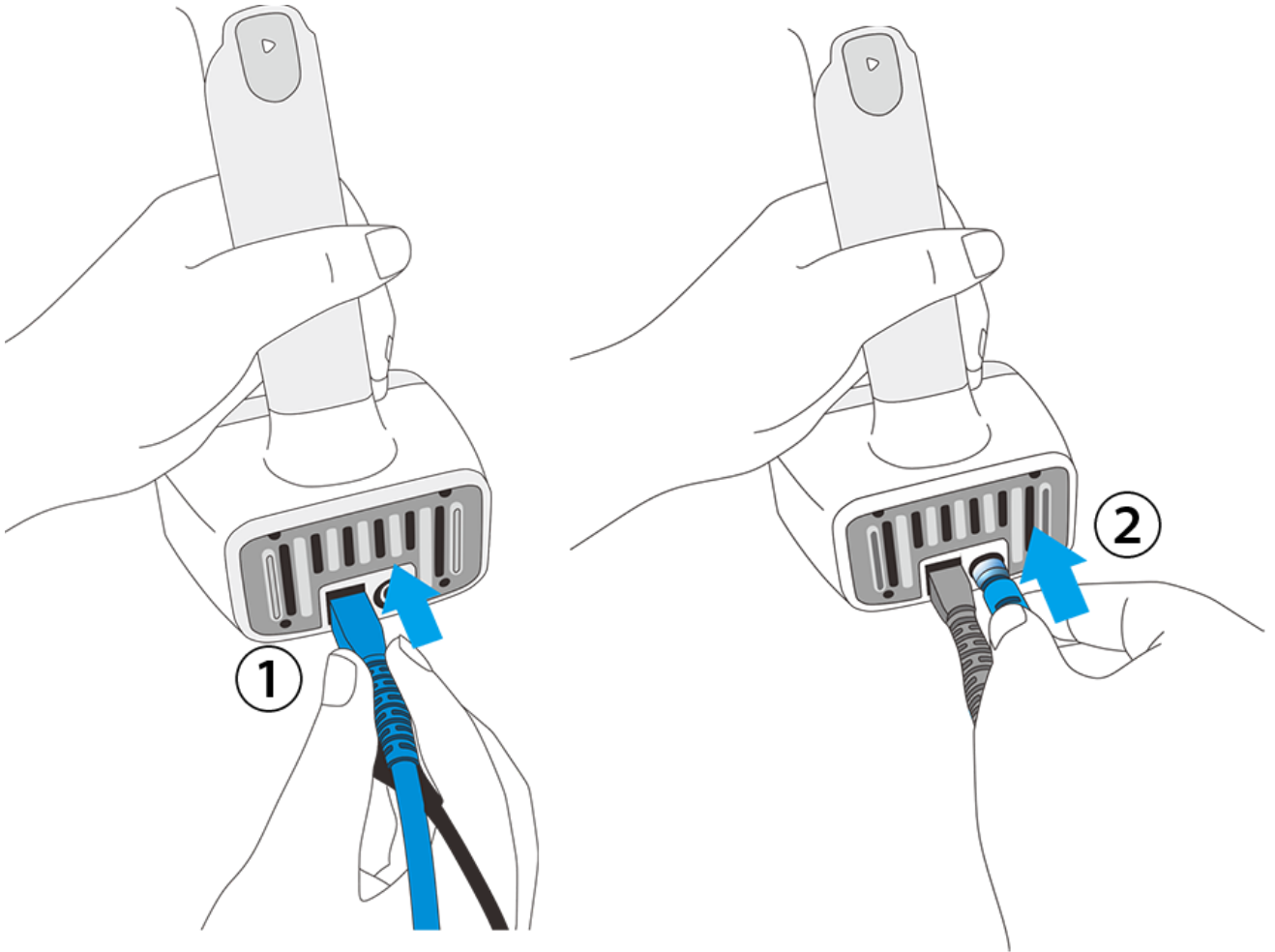

2. Plug the power cable into the connection cable.

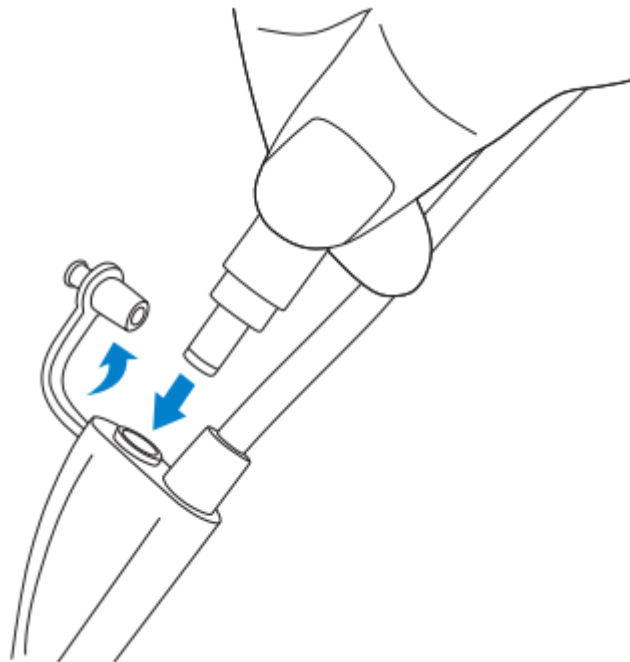

3. Power on and the LED indicator should show white.

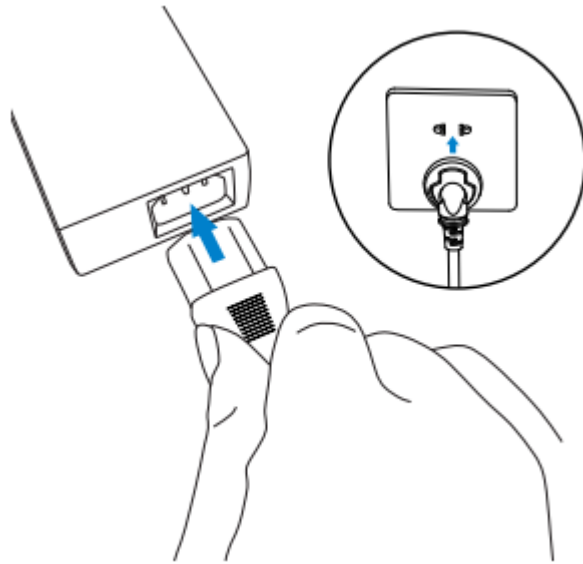





















4. Plug the other side of connection cable into the USB port of computer.

Now you can see our device in your Device Manager.

 Device Manager

File Action View Help



- >  Audio inputs and outputs
- >  Batteries
- >  Biometric devices
- >  Bluetooth
- >  Cameras
- >  Computer
- >  Disk drives
- >  Display adapters
- >  Firmware
- >  Human Interface Devices
- >  Keyboards
- >  Mice and other pointing devices
- >  Monitors
- >  Network adapters
- >  Portable Devices
- >  Print queues
- >  Processors
- ▼  Shining3D
  -  Einscan H2
- >  Software components

# Installation

To use the scanner, you need to install the **EXScan** software first (hereinafter referred to as the "software").

## Computer & Operating system requirement

Recommended computer:

| Component       | Model                         |
|-----------------|-------------------------------|
| CPU             | Intel® Core™ i7-8700 or above |
| Graphics card   | NVIDIA GTX 3060 or above      |
| Graphics memory | 4GB or above                  |
| RAM             | 32GB or above                 |
| USB             | 3.0 or above                  |

Recommended operating system: Windows 10, Windows 11 (both 64-bit only)

### CPU

Improper computer configuration or hardware issues will cause CPU performance degradation and affect the user experience, it is recommended to use the CPU-Z tool to check CPU performance before starting scanning.

CPU-Z: <https://www.cpuid.com/softwares/cpu-z.html> (<https://www.cpuid.com/softwares/cpu-z.html>)

Install and launch CPU-Z, follow the steps in below figure to get a CPU multi thread performance score. A score of **4000** or more is required.

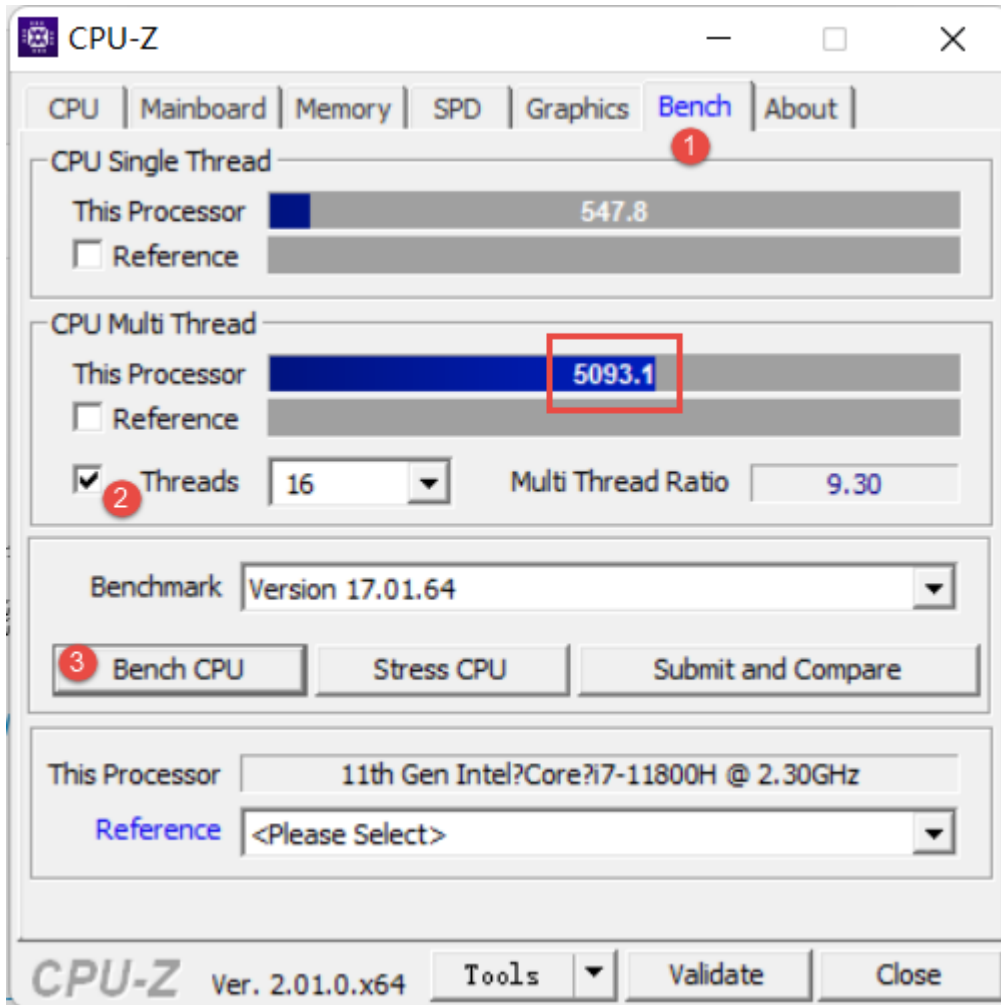

## OpenGL

To use the scanner, you need a graphics card (integrated or discrete) which can support **OpenGL4.3** or above.

Use [OpenGL Extensions Viewer \(https://realtech-vr.com/home/glview\)](https://realtech-vr.com/home/glview) to check the OpenGL version, if it's lower than 4.3, please update the graphics card driver and check again. If it's still lower than 4.3, it means that the graphic card CAN NOT support the scanner.

The screenshot shows the OpenGL Extensions Viewer interface. The title bar reads "OpenGL Extensions Viewer - 6.3.7.0". The top navigation bar includes a home icon, a download icon, and a menu icon. The "Renderer" is set to "NVIDIA GeForce RTX 3060 Laptop GPU/PCIe/SSE2 (Forward Conte..." and the "Database" is "OpenGL.org".

The main content area is titled "View basic information about your graphics renderer". It is divided into several sections:

- System informations:** Includes fields for "Renderer" (NVIDIA GeForce RTX 3060 Laptop GPU), "Adapter RAM" (6144 MB), "Monitors" (Generic PnP Monitor), "Resolution", "Operation system" (Microsoft Windows 11 家庭中文), and "Processor" (11th Gen Intel(R) Core(TM)).
- OpenGL:** A red box highlights the "Version" field, which shows "4.6" and "4.6.0 NVIDIA 472.56".
- DirectX:** Includes "Driver version" (Geforce™ Drivers 472.56, 11-3-2021, Version94.6.1f.0.1f) and "Supported profiles" (12.1, 11.4).
- Vulkan:** Includes "Version" (1.2.175).

A sidebar on the left contains "Tasks" (Summary, Extensions, Display modes & pixel formats, GL Rendering tests, Vulkan Rendering tests, Database, OpenGL Report, Vulkan Report, CPU Report, Submit Report, Technical Support) and "See also..." (Find OpenGL drivers, Check for updates, About ...). At the bottom, there are links for "Get version for" Android, iOS, and macOS.

At the bottom of the window, a status bar shows "Ready" and a message: "A more updated display drivers exists for your video card. Click 'Get the latest version'."

## GPU

Highly recommend to use a NVIDIA<sup>1</sup> discrete graphics card for the scanner.

The NVIDIA discrete graphics card should support **CUDA10.2** or above.

Use **NVIDIA Control Panel** to get the CUDA version with follow steps.

- Launch **NVIDIA Control Panel**
- Go to **Help>>System information>>Components**.



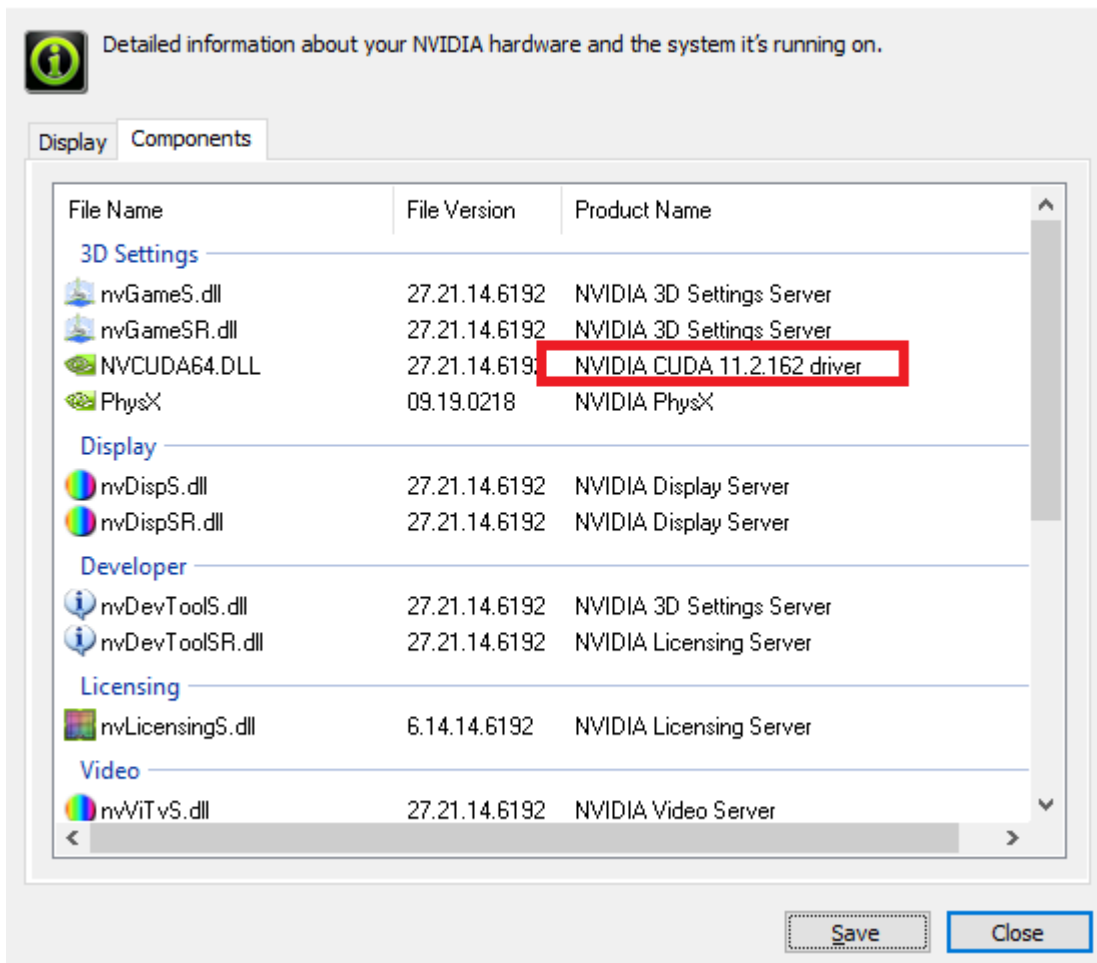

Detailed information about your NVIDIA hardware and the system it's running on.

Display Components

| File Name          | File Version  | Product Name                |
|--------------------|---------------|-----------------------------|
| <b>3D Settings</b> |               |                             |
| nvGameS.dll        | 27.21.14.6192 | NVIDIA 3D Settings Server   |
| nvGameSR.dll       | 27.21.14.6192 | NVIDIA 3D Settings Server   |
| NVCUDA64.DLL       | 27.21.14.6192 | NVIDIA CUDA 11.2.162 driver |
| PhysX              | 09.19.0218    | NVIDIA PhysX                |
| <b>Display</b>     |               |                             |
| nvDispS.dll        | 27.21.14.6192 | NVIDIA Display Server       |
| nvDispSR.dll       | 27.21.14.6192 | NVIDIA Display Server       |
| <b>Developer</b>   |               |                             |
| nvDevTools.dll     | 27.21.14.6192 | NVIDIA 3D Settings Server   |
| nvDevToolsSR.dll   | 27.21.14.6192 | NVIDIA Licensing Server     |
| <b>Licensing</b>   |               |                             |
| nvLicensingS.dll   | 6.14.14.6192  | NVIDIA Licensing Server     |
| <b>Video</b>       |               |                             |
| nvVITvS.dll        | 27.21.14.6192 | NVIDIA Video Server         |

Save Close

### Use a discrete graphics card on desktop

- Connect your monitor to the port of discrete graphics card on the back of your computer, OS will use the discrete graphics card automatically.

### Use a discrete graphics card on laptop

- Launch **NVIDIA Control Panel** on your laptop.
- In **3D Settings** --> **Manage 3D Settings** --> **Global Settings**, select **High-performance NVIDIA processor** and **Apply**.

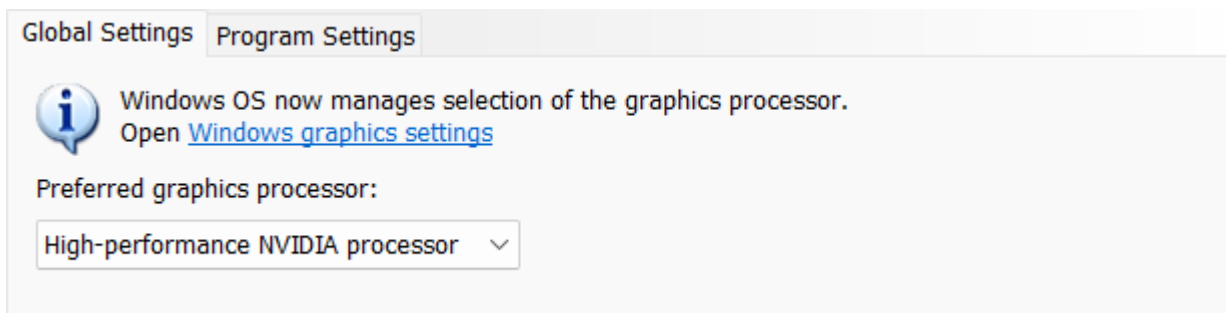

Global Settings Program Settings

Windows OS now manages selection of the graphics processor.  
Open [Windows graphics settings](#)

Preferred graphics processor:

High-performance NVIDIA processor

### Get the installation package

Please visit the following website to get the installation package: <https://www.einscan.com/support/download>  
(<https://www.einscan.com/support/download/>)

## Install the software

Please follow the installation wizard to install the software.



### Note

- Administrator rights are required for the software installation. The initial installation environment may take a long time, please wait patiently.
- Please do not install the software in **C:\Program Files** or **C:\Program Files (x86)**. The software will not run when installed under these folders due to restricted rights.

---

1. We use CUDA from NVIDIA to get high scanning experience. ←

# Activation

When using the scanner for the first time, please register an account to activate the device.

## Register for Shining 3D User Account

Click **Register** and fill in the account information in the registration pop-up.



### Create an account

+1 United States ▼

State/region do not support modification after submission,  
please choose cautiously

Enter phone number or email

>> Please slide to verify

Please enter the verification code [Send Code](#)

Please enter your name

Enter at least 6 characters password

Please enter the password again

Read and agree our [《Privacy policy》](#) [《Terms of use》](#)

**Next Step**

## Note

- Enter valid email or phone number to get verify code for registration.
- Fill in correct user information for better service.

## Login

Log in Shining 3D User Account from the pop-up window when launching the software.

If your computer failed to connect to the network:

- Check the network connection and click **Refresh** to reconnect to the network. It will jump back to the login interface after successfully connecting to the network.
- If your computer can not connect to the network successfully, click **offline activation** to directly perform the offline activation.

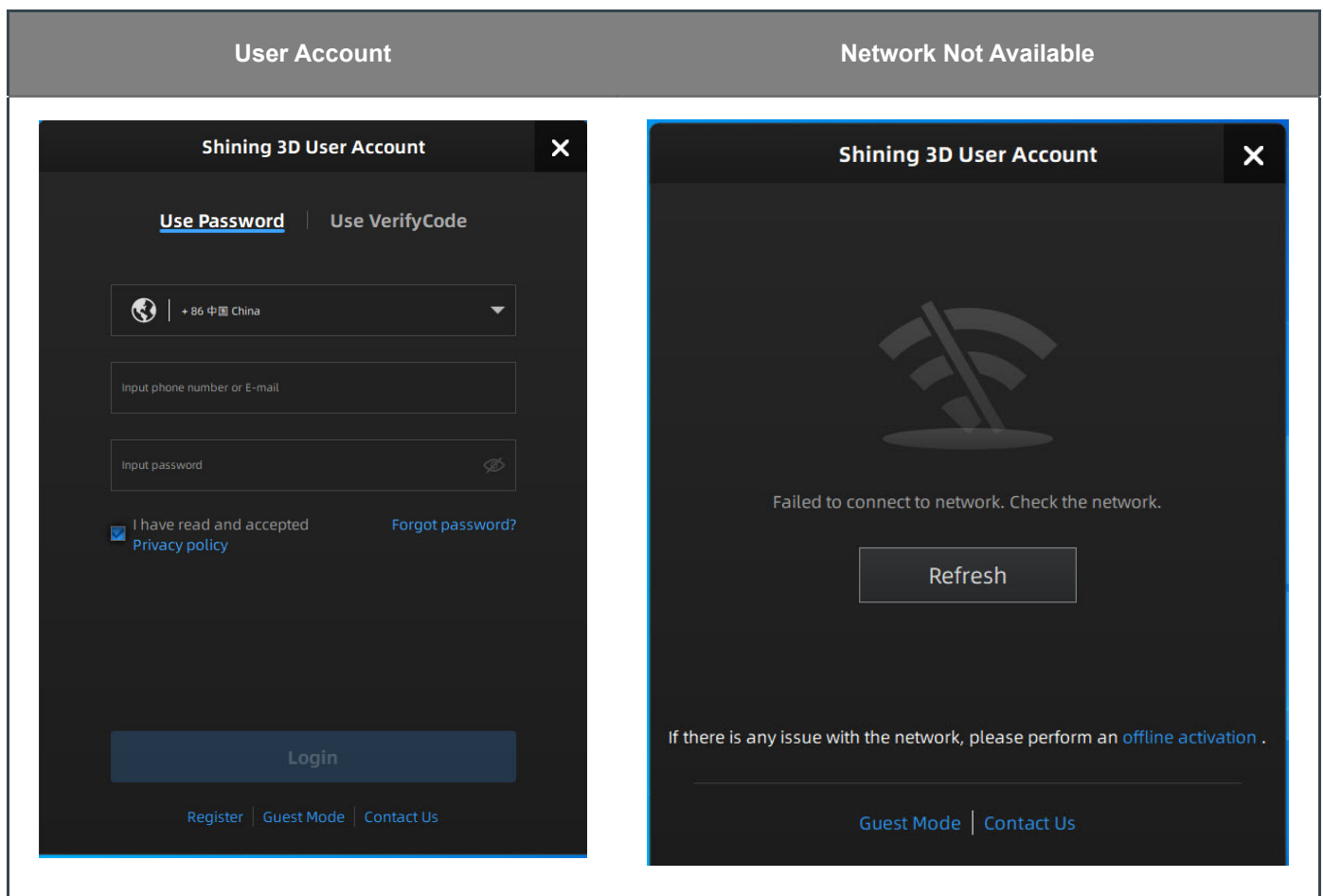

## Activate the device

### Online activation

If the computer is connected to the Internet, the activation will be processed automatically after you login Shining 3D User Account.

## Offline activation

You need another computer which is connected to Internet to help you finish the offline activation.

1. Connect scanner to the computer with no network, export C2V file.

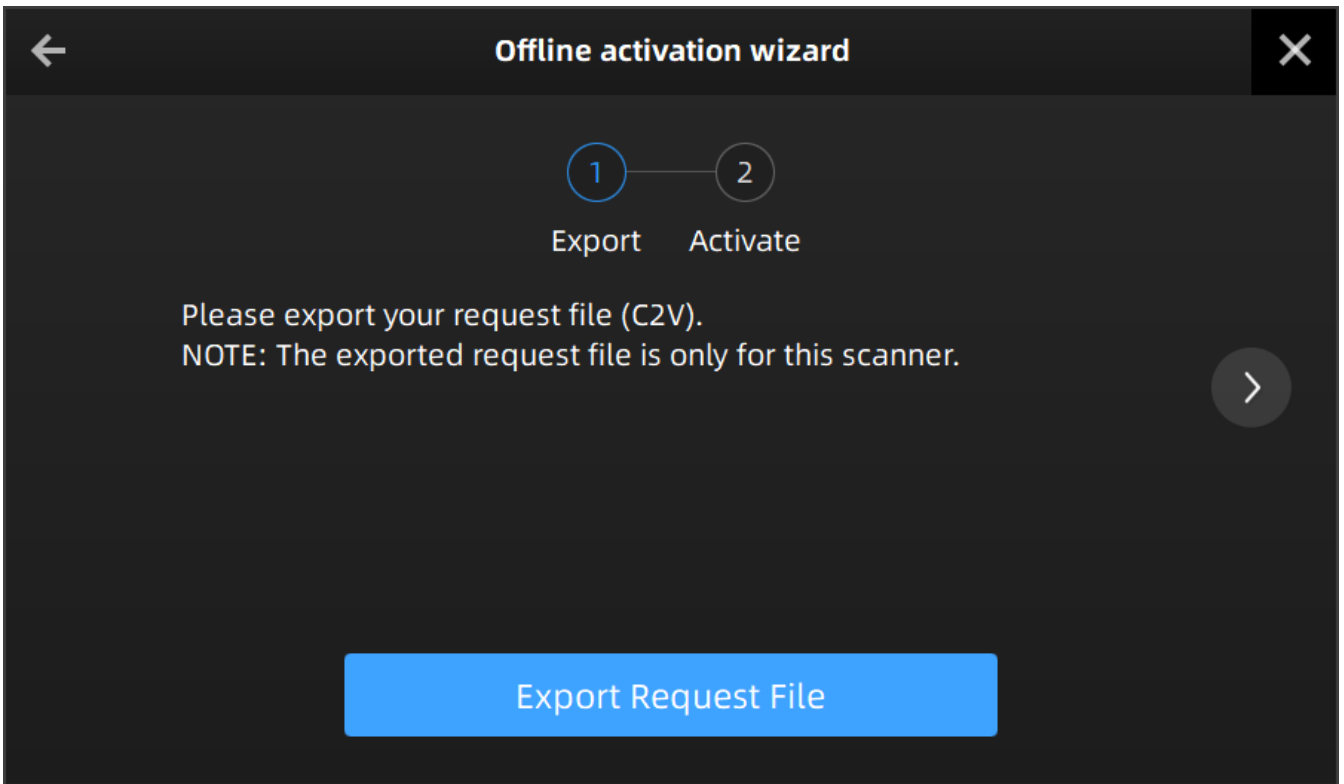

2. Copy the C2V file to the other computer connected to Internet.
3. On the computer with network, log in <https://passport.shining3d.com/> (<https://passport.shining3d.com/login?redirect=%2F>), upload your C2V file in **offline activation** page and complete the information of activation, you can then download the V2C file.

### Offline Activation ✕

 einscan-h\_active\_2022\_09\_13.c2v ✓

\* Company Name

\* Industry Applications

\* Data processing software

4. Copy the V2C file to the computer with no network, import the file into the software.

### Offline activation wizard ✕

1 — 2  
Export    Activate

Please transfer the request file (C2V) to a computer with internet access. Open the official website below to activate your scanner and download the activation file (V2C).

Official Website <https://passport.shining3d.com>

If you already have an activation file (V2C), import directly to complete activation.



### Note

If you fail to activate the device in neither way, please contact your supplier or our [support team](https://support.einscan.com/) (<https://support.einscan.com/>) .

# Upgrade

When new software is released, you will get prompted when launching the software. If the firmware in the software is newer than that in the scanner, you will get prompted too.

## Firmware upgrade

The firmware is running on the scanner, it will be upgraded for better performance, stability or bug fixing.

### Warning

Make sure that the device is powered on during the upgrade; avoid interruption of the upgrade due to power cuts.

When the scanner is connected, the software will automatically detect the firmware. If the firmware does not match, it will prompt you to upgrade the firmware. Click **Yes** to upgrade.

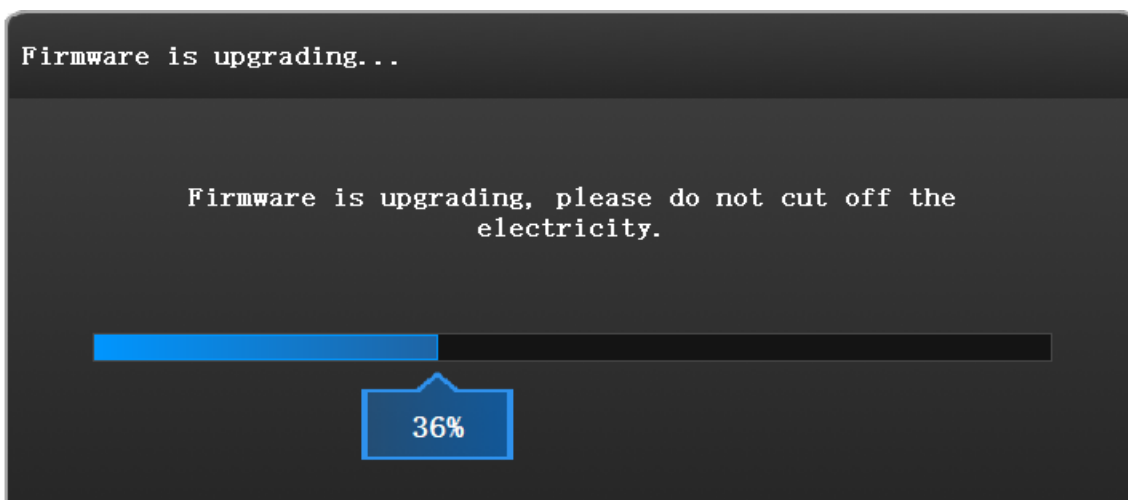

## Software upgrade

Software upgrade is to optimize software performance, add new functions or bug fixing.

### Warning

The software will be closed during upgrading, please save your projects properly before upgrading.

It is highly recommended to use the latest version of software. If not, a reminder will pop up immediately when you launch the software.



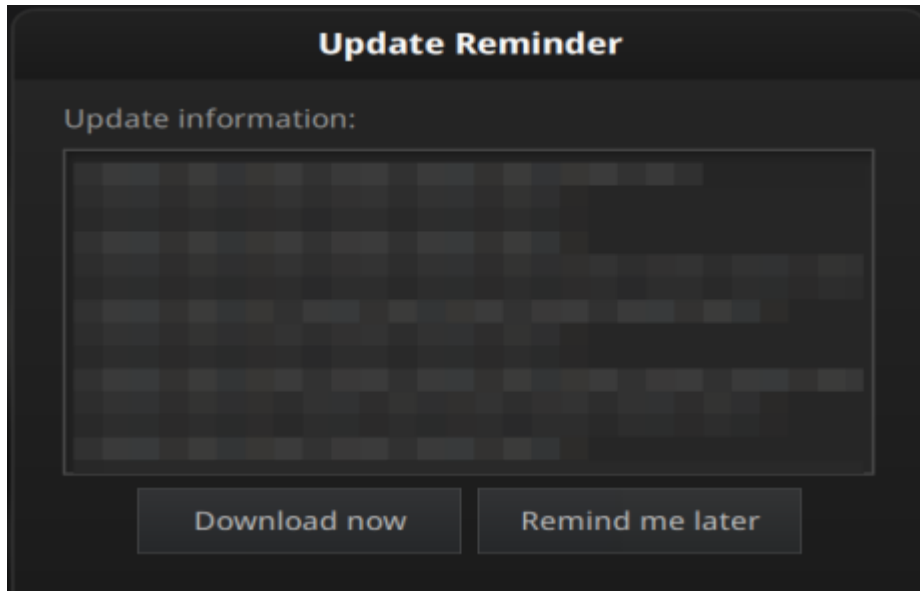

Click **Download Now** will download the new installation package in the background, you can continue using the software. Please do not close the software before the download has finished. Once it finished, the following prompt will show.

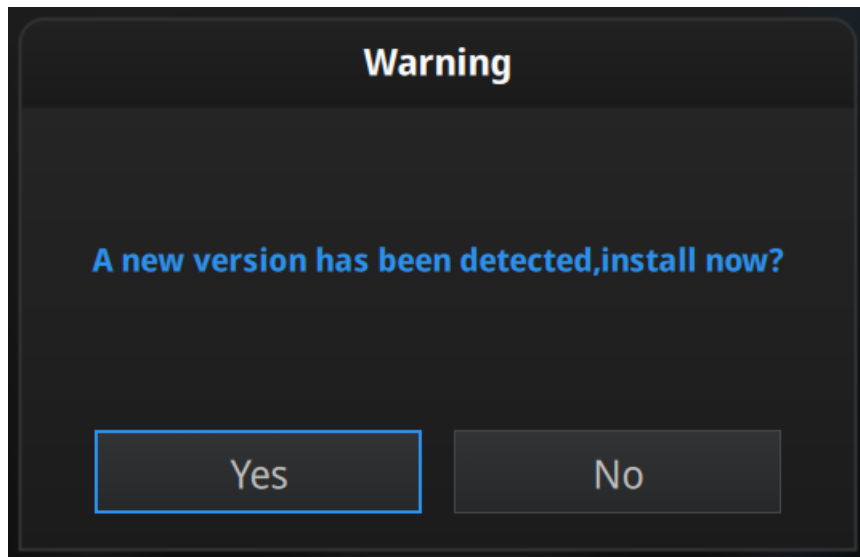

Click **Yes** to start the installation of the new version.

# Interface

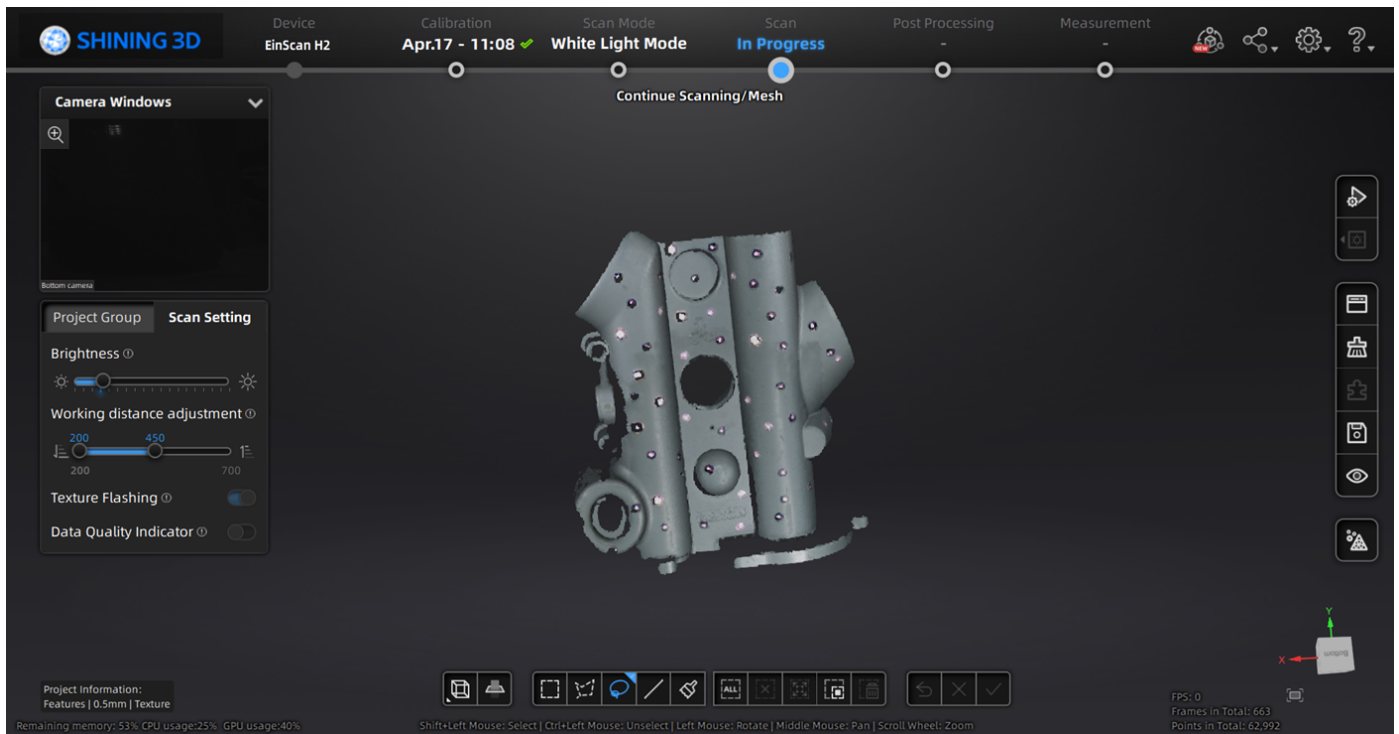

## Navigation bar

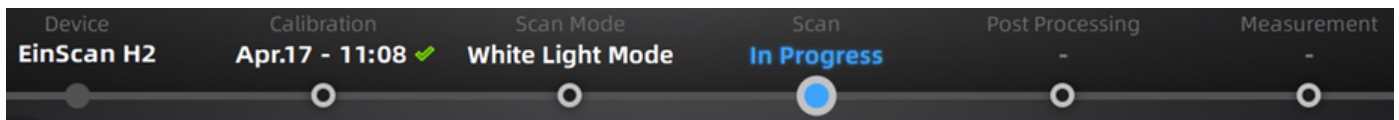

| Navigation      | Description                                                                                                             |
|-----------------|-------------------------------------------------------------------------------------------------------------------------|
| Device          | Displays the device status: online / offline                                                                            |
| Calibration     | Click to start <a href="#">calibration</a> .                                                                            |
| Scan Mode       | Select different scan mode: white light mode / IR mode                                                                  |
| Scan            | Into <a href="#">scan</a> process.                                                                                      |
| Post Processing | Into post processing after generating the point cloud, includes <a href="#">mesh</a> and <a href="#">mesh editing</a> . |
| Measurement     | Use the software to <a href="#">measure</a> your model.                                                                 |

## Settings and feedback

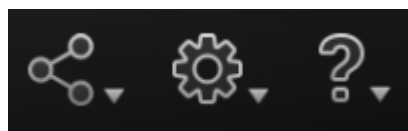

### Social

| Function         | Description                                                                                                                                                                                    |
|------------------|------------------------------------------------------------------------------------------------------------------------------------------------------------------------------------------------|
| Official Website | Open the <a href="https://www.einscan.com">official website (https://www.einscan.com)</a> of Shining 3D to learn about the company's products and information.                                 |
| Facebook         | Enter Shining 3D's <a href="https://www.facebook.com/groups/einscan">facebook (https://www.facebook.com/groups/einscan)</a> to view product introduction and other operations.                 |
| Support Platform | Enter Shining 3D's <a href="https://support.einscan.com/en/support/home">support platform (https://support.einscan.com/en/support/home)</a> to view product introduction and other operations. |

### Settings

| Function        | Description                                                                                                                                                                                                                                                 |
|-----------------|-------------------------------------------------------------------------------------------------------------------------------------------------------------------------------------------------------------------------------------------------------------|
| User Experience | To help us improve the quality and user experience of the device, we hope to be allowed to collect usage experience information. This information will not contain your personal information or scanned data and will not be accessible to any third party. |
| Factory Default | All settings can be restored to the initial settings, and the software will automatically restart.                                                                                                                                                          |
| Language        | To select other language.                                                                                                                                                                                                                                   |
| About           | View related software release information, contact information, etc.                                                                                                                                                                                        |

## Help

| Function          | Description                                                                                                                             |
|-------------------|-----------------------------------------------------------------------------------------------------------------------------------------|
| Calibration Guide | Checked by default. It will display guide in calibration.                                                                               |
| User Manual       | Open a browser to show user manual.                                                                                                     |
| Teamviewer        | The quick access to remote assistance. Send the ID and password in the pop-up window to the technical supporters for remote assistance. |

# Other components

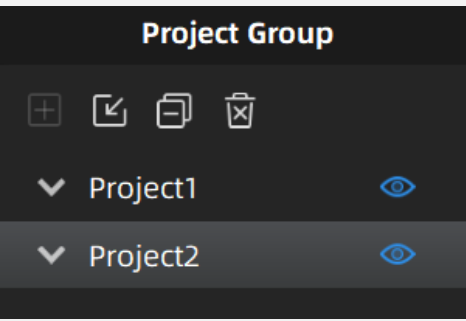
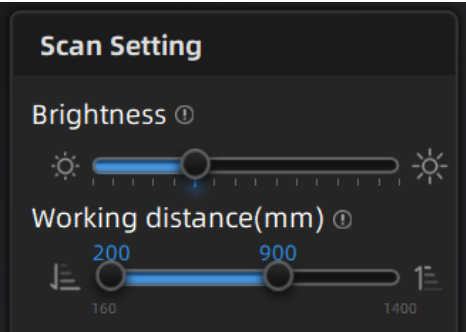
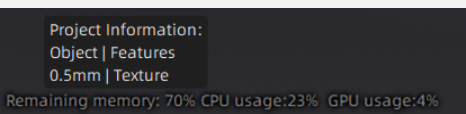
| Component                                                                                                      | Description                                                                                                                               |
|----------------------------------------------------------------------------------------------------------------|-------------------------------------------------------------------------------------------------------------------------------------------|
| <p>Camera Window</p>          | <p>This is the camera window in <b>scan</b> process. Show one by default, you can open other camera windows through Right-click menu.</p> |
| <p>Project Group</p>         | <p>Here you can manage your project group, for more detail please refer to <a href="#">Project and project group</a>.</p>                 |
| <p>Scan Setting</p>         | <p>Here you can set the parameter when scanning, for more detail please refer to <a href="#">Scan Setting</a>.</p>                        |
| <p>Project Information</p>  | <p>In this area, you can check the project information and other information such as the remaining memory, CPU usage and GPU usage.</p>   |

| Component                                                                                                                                       | Description                                                                                                                                                                                                                                           |
|-------------------------------------------------------------------------------------------------------------------------------------------------|-------------------------------------------------------------------------------------------------------------------------------------------------------------------------------------------------------------------------------------------------------|
| <p data-bbox="134 248 437 277">Working distance indicator</p>  | <p data-bbox="580 248 1294 277">Indicate working distance between the scanner and the object.</p> <p data-bbox="580 293 740 322">Green: proper</p> <p data-bbox="580 333 740 362">Red: too close</p> <p data-bbox="580 374 719 403">Blue: too far</p> |
| <p data-bbox="134 667 181 696">Edit</p>                                                                                                         | <p data-bbox="580 667 863 696">Please refer to <a href="#">Data edit</a>.</p>                                                                                                                                                                         |
| <p data-bbox="134 757 225 786">Sidebar</p>                                                                                                      | <p data-bbox="580 757 916 786">Please refer to <a href="#">Scan function</a>.</p>                                                                                                                                                                     |

# Quick guide

1. Select [scan mode](#).
2. Create a [project group](#), setup [project settings](#).
3. Set [scan parameters](#) while [preview](#) .
4. [Scan](#) and [generate point clouds](#).
5. [Mesh](#).
6. [Save](#) the scan data.

# Calibration

With **calibration**, the scanner parameters are recalculated, which not only ensures the accuracy of the scanner, but also improve the quality of scanning.

## Note ▼

Calibration is required under the following conditions:

- When the scanner is used for the first time.
- The scanner was severely shaken or shocked, such as shocked during transportation.
- Severe accuracy reduction, such as frequent errors in alignment or unrecognized markers.
- Incomplete data is acquired during the scanning or serious deterioration of the quality of scanned data.
- When the scanner is NOT calibrated more than 14 days, the software will prompt you to do calibration.

## Warning ▼

- The calibration board is matched to the device. Doing the calibration with an incorrect calibration board will fail to generate good scan data or optimum accuracy.
- Always make sure that both sides of the calibration board are clean and free of scratches.
- Do not place heavy objects or sundries on the calibration board.
- Keep the calibration board away from corrosives, metals and sharp objects to avoid corrosion or damage.
- It is not recommended to wipe the calibration board. When cleaning the board becomes very necessary, gently wipe it with a piece of a clean damp cloth. Do not use a cloth with chemicals or alcohols to wipe the calibration board.
- After using the calibration board, put it safely in a box or flannel bag.

## Standard calibration

For the first time use, you will be guided to **Standard calibration** when you click **Calibration** button.

Follow the steps of the calibration wizard in the software. You need to calibrate the scanner from 5 different directions.

1. Follow the instruction in the picture to place the calibration board onto the holder, with its front site (black with markers) towards the scanner.



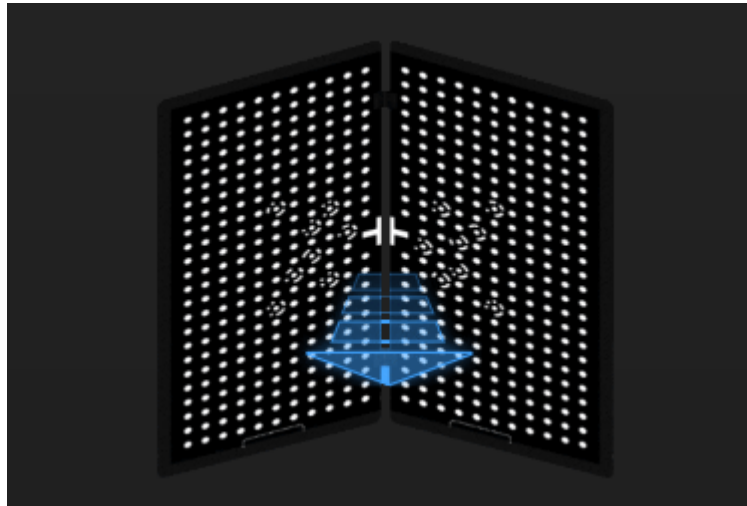

2. Press the scan button on the scanner to start calibration.
3. Move the device slowly and adjust the distance between the scanner and the calibration board according to the height indicating box.

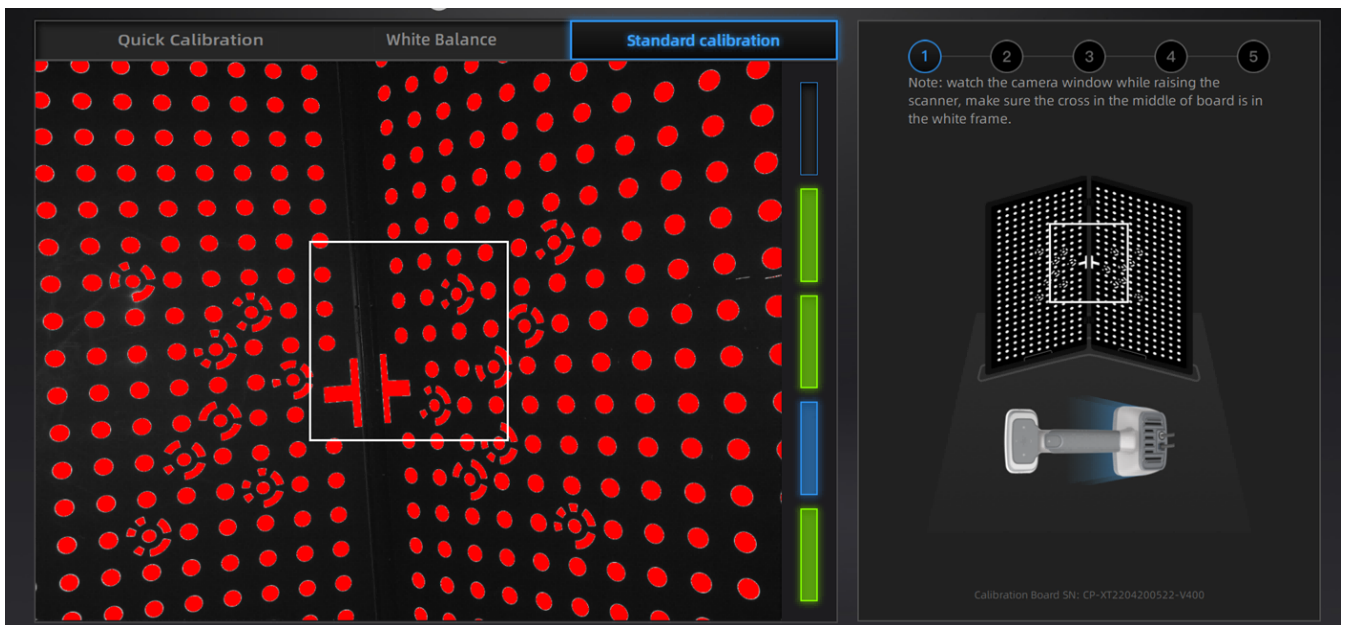

4. Keep moving until all height boxes turn green.
5. Place the scanner in the next position and repeat step 2 ~ 4.
6. Finish calibration and check the calibration result.

## Camera Calibration

# Calibration succeeded

After the calibration is completed, it is recommended that the calibration board be stored properly to prevent scratches or damage.

Next



### Note

- If the calibration fails, please try it again from step1.
- If you cannot get the pass result anyway, please contact your supplier or our [support team](https://support.einscan.com/) (<https://support.einscan.com/>) .

## White balance

1. Place the calibration board on a horizontal flat surface with its back site (white) lying towards up.
2. Hold the scanner face to the center of board in upright position.
3. Press the scan button on the scanner to start calibration.
4. Keep moving the scanner up and down slowly until the scanner takes a photo automatically, which indicates that the distance is optimal.

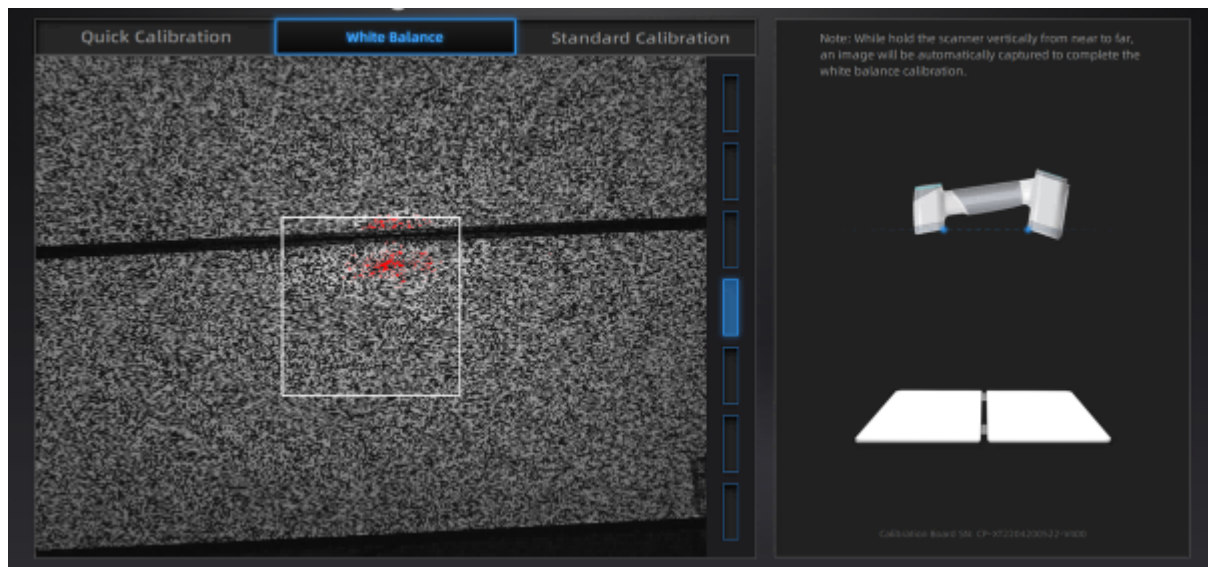

After finishing the white balance calibration, click Next on the following pop-up for entering the scan mode.

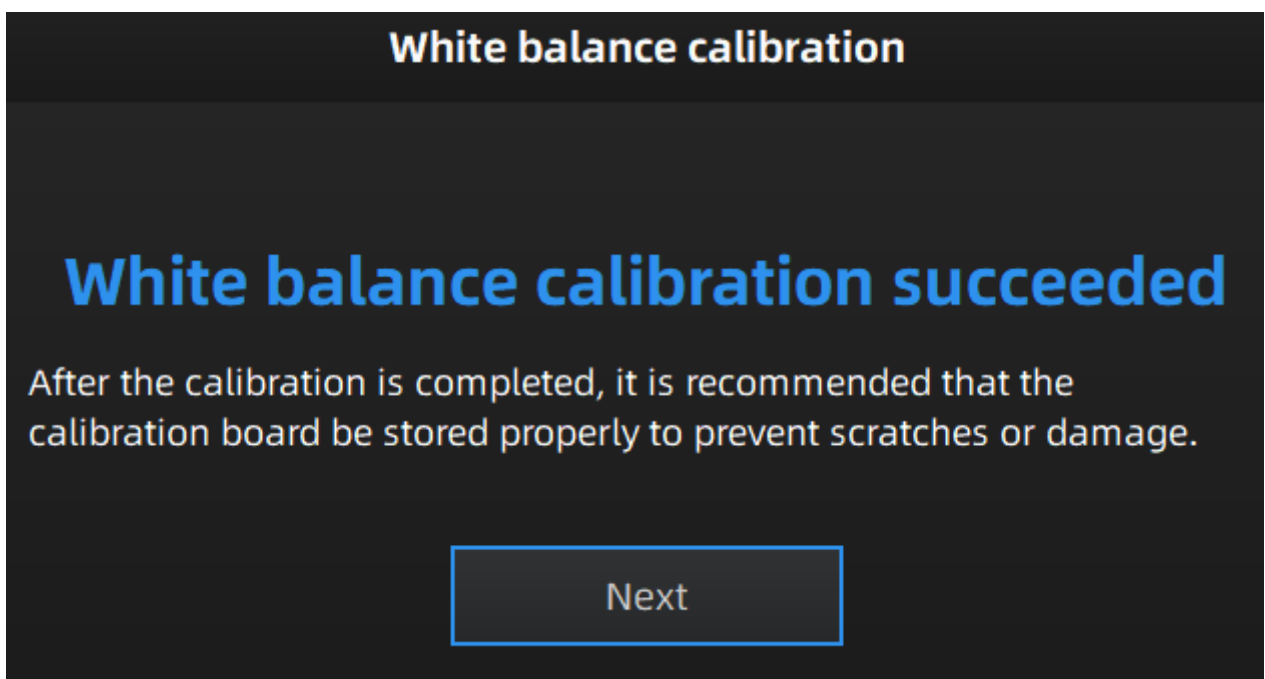

#### Note

- Do not do white balance or scan under strong light, it may cause color deviation.
- If white balance fails, please try it again.
- If you cannot get the pass result anyway, please contact your supplier or our [support team](https://support.einscan.com/) (<https://support.einscan.com/>) .

## Quick calibration

Quick calibration can be used for re-calibration when accuracy reduction or misalignment during scanning. Only one position should be done during quick calibration.

1. Place the calibration board onto the holder, with its front site (black with markers) towards the scanner.
2. Place the scanner as shown in the software, then press the scan button on the scanner to start calibration.
3. Move the device slowly and adjust the distance between the scanner and the calibration board according to the height indicating box.

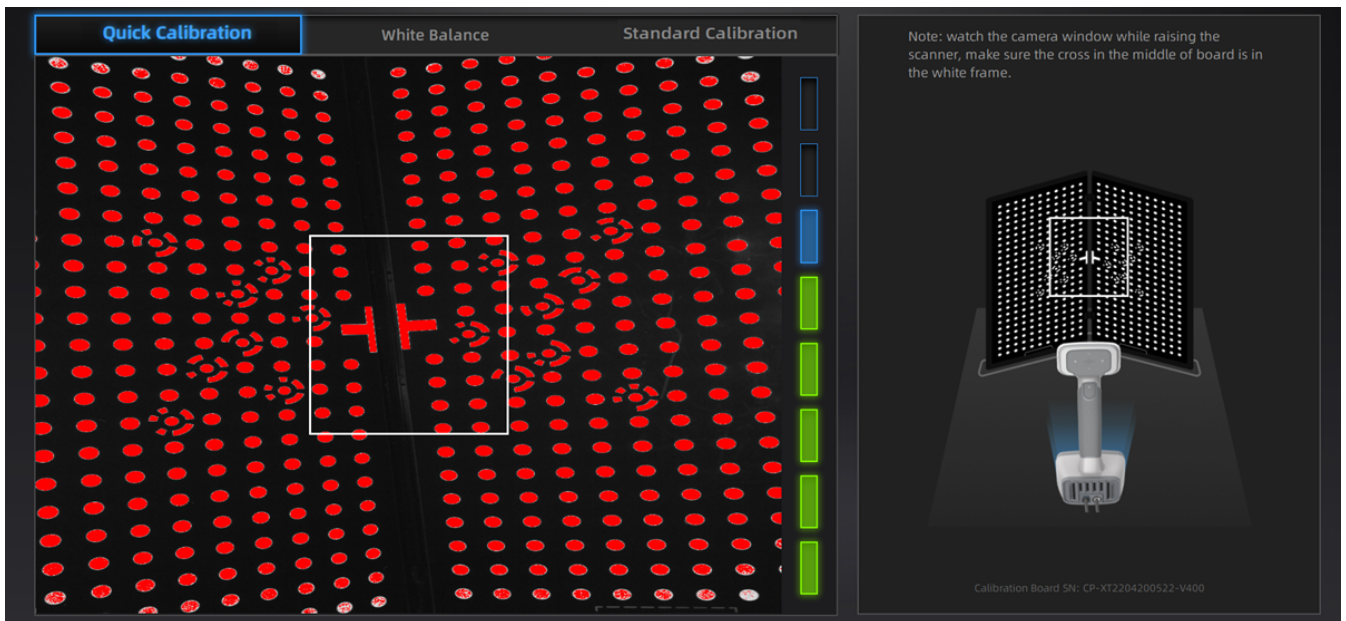

4. Keep moving until all the eight boxes turn green.
5. Finish calibration and check the calibration result.

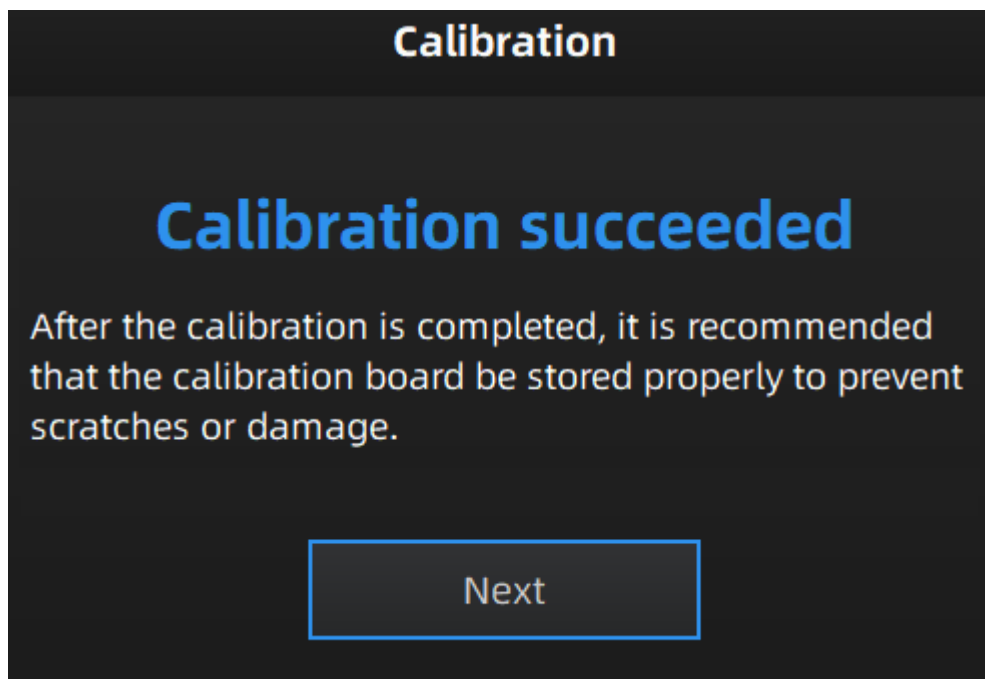

Scan

# Workflow

Below is the workflow of the scanner. There are two different workflows: Basic workflow, Global marker workflow.

The basic workflow can fulfill most of your needs, if you want higher accuracy, you can use global marker workflow.

# Basic Workflow

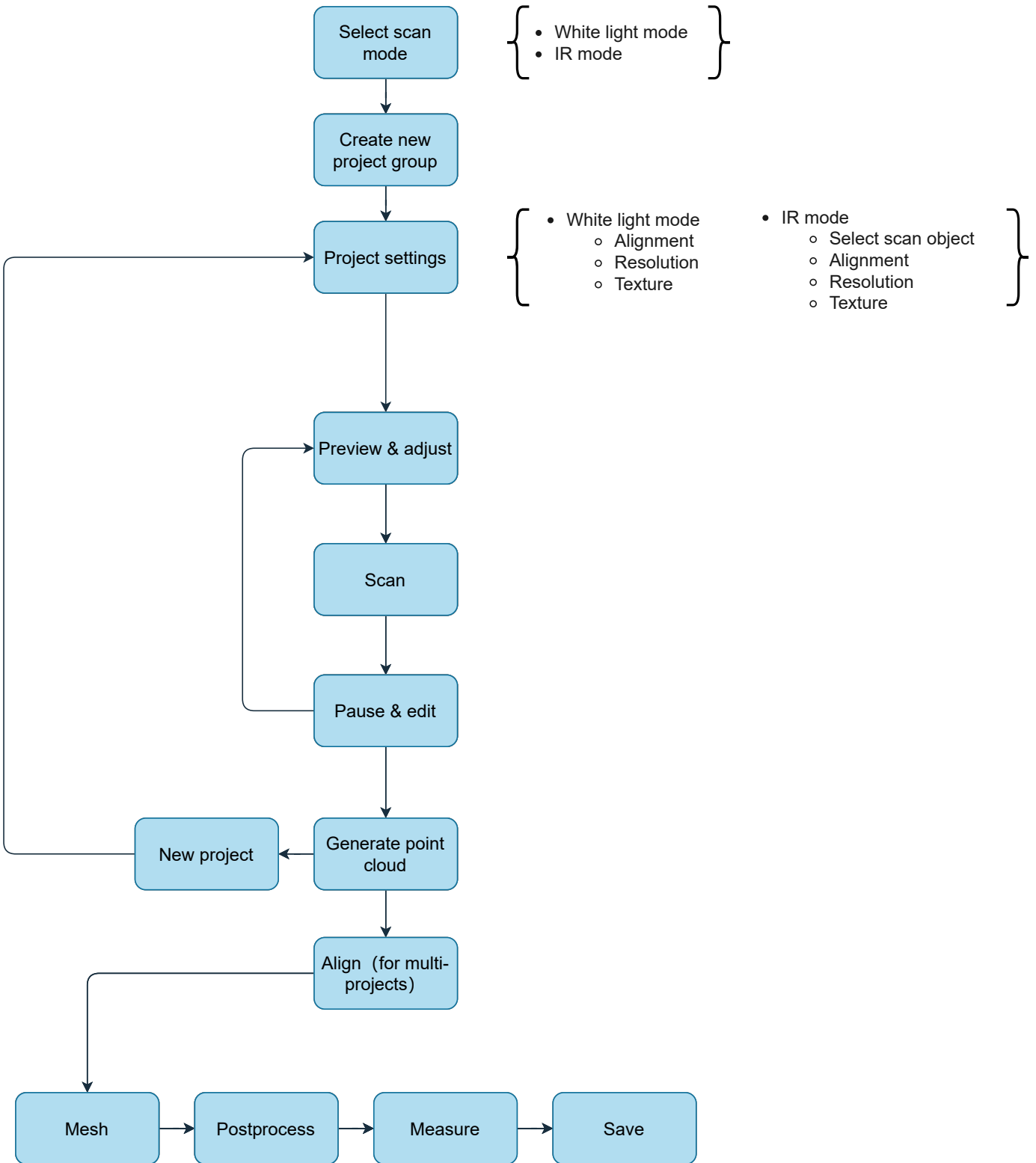

# Global Marker Workflow

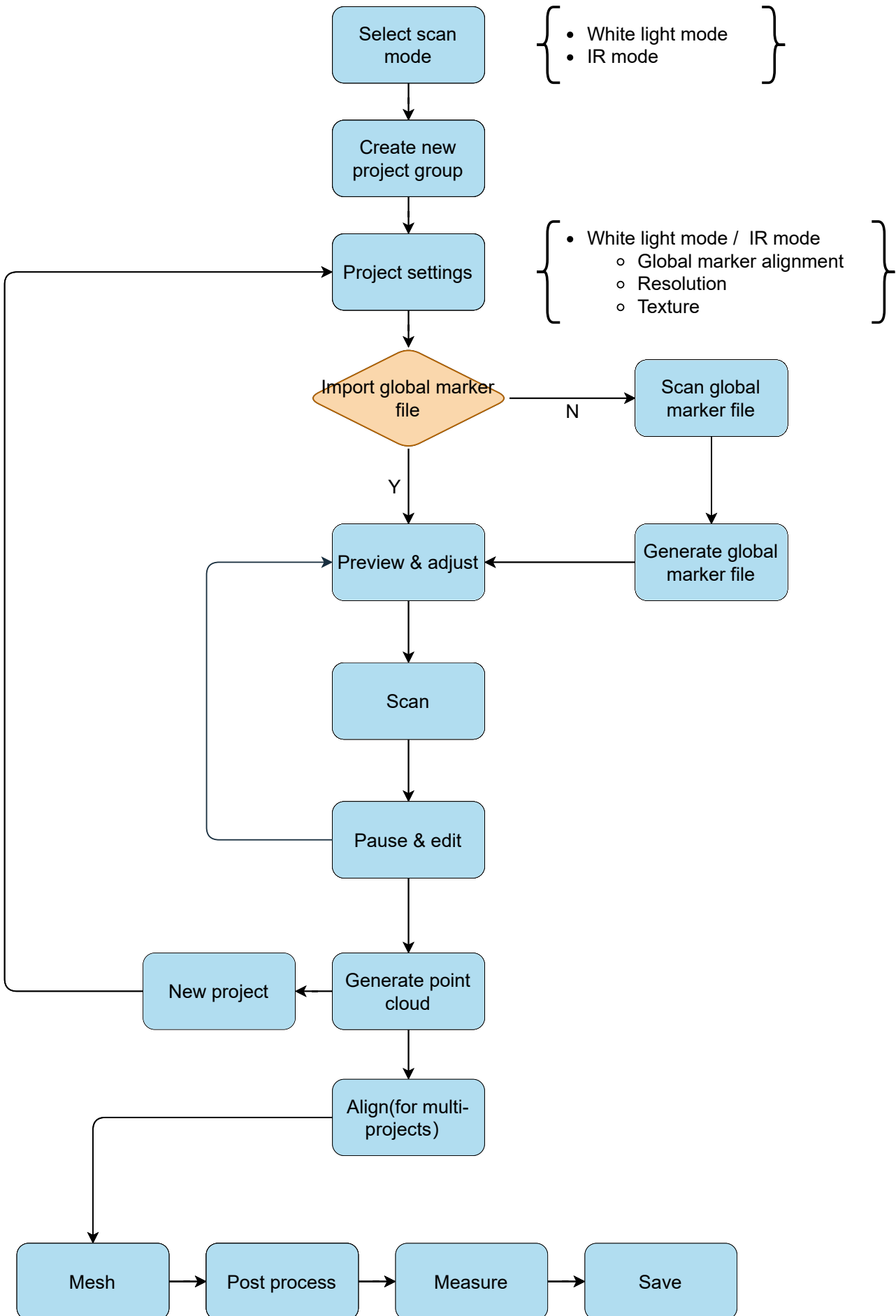



# Preparation

Object has good geometry or texture features will get scanned easily and fast with good quality. If not, you need to do some preparation before scanning.

## Note

Not recommend to scan following objects:

- Moving or vibrating objects, which cause the shape of object changed during scanning process.
- Soft material object.
- Lattice structures with many small deep holes.

## Preparation for portrait scan

### Hair



## Preparation for different object

| Object                                            | Preparation                                                                                                                       | Notes while scanning                                                                                          |
|---------------------------------------------------|-----------------------------------------------------------------------------------------------------------------------------------|---------------------------------------------------------------------------------------------------------------|
| Transparent, shiny, reflective surface objects    | Use washable or vanishing scanning spray                                                                                          | Scan as normal                                                                                                |
| Objects with less features or repetitive features | <ul style="list-style-type: none"><li>- Place markers on the object.</li><li>- Mark/draw on the surface to add features</li></ul> | <ul style="list-style-type: none"><li>- Select hybrid alignment.</li><li>- Select texture alignment</li></ul> |
| Thin wall objects                                 | Place markers on and around the objects                                                                                           | Choose global marker alignment                                                                                |

# Scan mode

There are two scan modes: **White light mode** and **IR mode**.

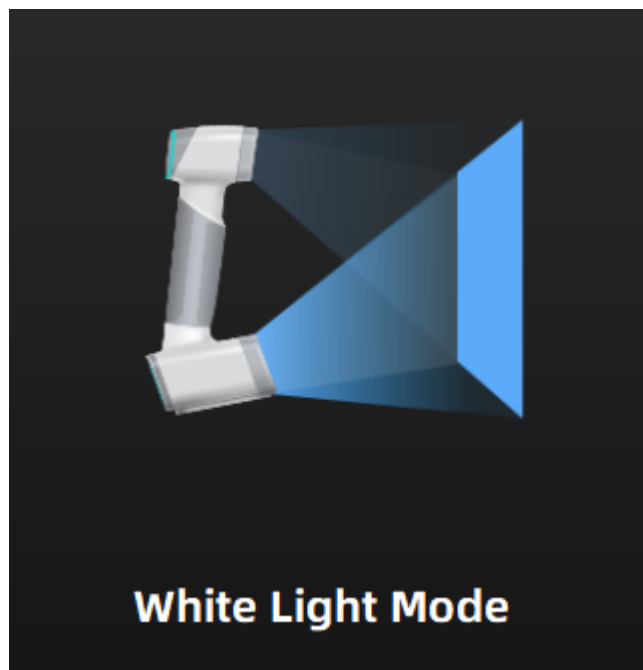

## White light mode

Use white light source for scanning, with higher scan data quality and accuracy, suitable for scanning non-reflective, non-black material objects.

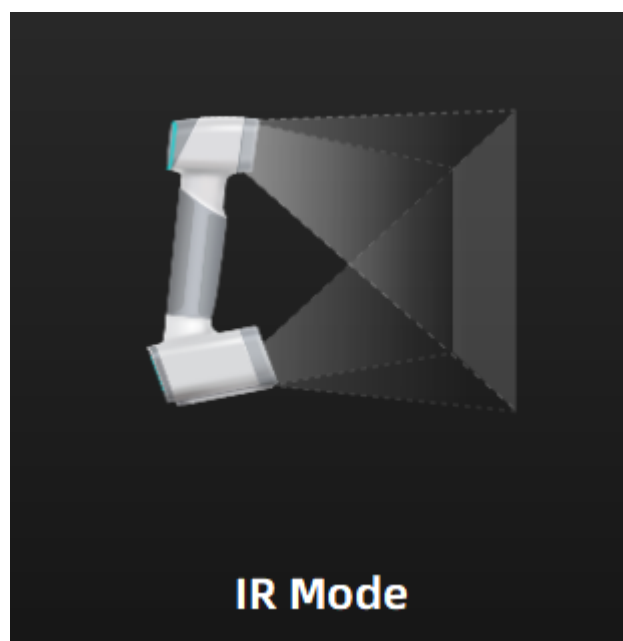

## IR mode

Use the infrared light for scanning, the data quality and scan accuracy are lower than the white light mode, it is often used to scan people and black or slightly reflective materials.

# Project and project group

## Project group

To start scanning, you need to create / open a **project group**. Project group is the standard file structure of the software, it contains one project or more. Each project contains the scan data of its own.

| Project Group                          | Scenario                                                                                                                                                                                               | Description                                                                                                                                                                                                                      |
|----------------------------------------|--------------------------------------------------------------------------------------------------------------------------------------------------------------------------------------------------------|----------------------------------------------------------------------------------------------------------------------------------------------------------------------------------------------------------------------------------|
| Only one project in the project group  | One object needs to scan with only one alignment mode.                                                                                                                                                 | Only one alignment mode can be used in the same project.                                                                                                                                                                         |
| Multiple projects in the project group | <ul style="list-style-type: none"><li>• One object needs to scan with multiple alignment modes.</li><li>• Multiple objects or one large object need to scan with one or more alignment modes</li></ul> | It is recommended to create multiple projects within one project group when scanning the large object, multiple objects and one projects with multiple alignment modes. After scanning, you can align these projects one by one. |

## Create project group

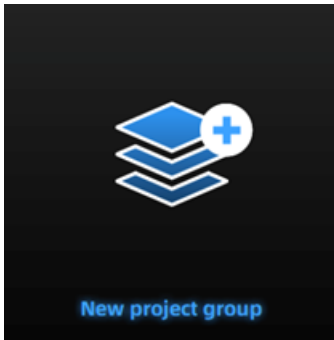

Two ways to create a project group:

1. Before scanning, select **scan mode**, then click **new project group** in prompt.
2. In **scan** window, click **project group** in side bar, then click **new project group** in prompt.

In the prompt window, name the project group and **new** to the path you choose, all the scan data will be saved to the folder with the name you just set.

## Open project group

## Note

Current project group will be saved automatically.

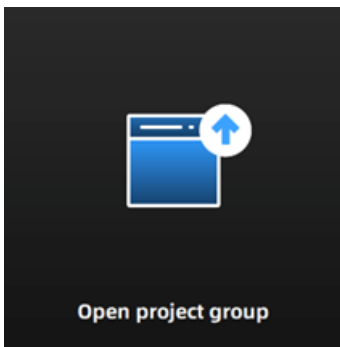

Two ways to open a project group:





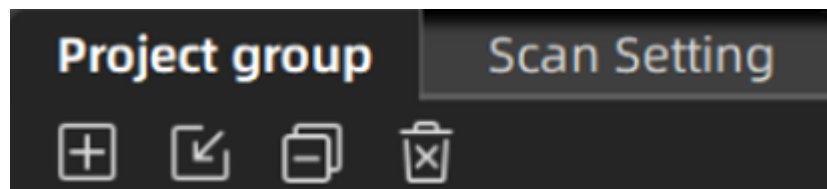

1. Before scanning, select **scan mode**, then click **open project group** in prompt.
2. In **scan** window, click **project group** in side bar, then click **open project group** in prompt.

In the prompt window, select the project group file and then **open**.

## Project

Consider each **project** as a part of the **project group**. All operations of project can be done by the following buttons.



| icon                                                                                | function           | instruction                                                                                                                                                                                                                                             | note & warning                                                          |
|-------------------------------------------------------------------------------------|--------------------|---------------------------------------------------------------------------------------------------------------------------------------------------------------------------------------------------------------------------------------------------------|-------------------------------------------------------------------------|
|    | Create new project | Two ways to create a project:<br>1. A project will be created automatically when you create a project group.<br><br>2. In scan window, click  to create a new project. | Only can create project when scanner connected.                         |
|    | Open project       | Two ways to open project:<br>1. When opening a project group, all project(s) of this group will be loaded to the software.<br>2. Click to open the project of one project group.                                                                        | Cannot open project with different resolution or texture setting.       |
|    | Remove project     | Click  to remove selected project from the project tree.                                                                                                               | The data will not be deleted, you can open the project when needed.     |
|  | Delete project     | Click  to delete the project from the project tree, and delete all the data of this project.                                                                         | This operation will delete the scan data from the computer permanently. |

# Project setting

White light mode



## Alignment

| Alignment      | Instruction                                                                                                                                                                                                                                                                                                   |
|----------------|---------------------------------------------------------------------------------------------------------------------------------------------------------------------------------------------------------------------------------------------------------------------------------------------------------------|
| Feature        | Uses object geometric features for auto aligning during scanning. Rich features on the object are required for this mode.                                                                                                                                                                                     |
| Texture        | Uses objects surface texture to align the scans. Compared with feature alignment, texture alignment takes longer and consumes more memory. It is recommended to use the texture alignment only in cases where the object's geometrical features are insufficient.                                             |
| Global Markers | Uses global markers file to help align the scans. You may add an existed global markers file or scan one.                                                                                                                                                                                                     |
| Hybrid         | Uses features, markers to align the scans. Use the function to avoid alignment error in some target parts. By this alignment, we do not need to place the markers all over the part, but only on the region where has less geometry. Global markers files can be imported to assist in scanning and aligning. |

## Resolution

| Resolution  | Instruction      |
|-------------|------------------|
| 0.2mm ~ 3mm | 0.5mm by default |

## Texture

| Texture          | Icon                                                                                | Instruction                    |
|------------------|-------------------------------------------------------------------------------------|--------------------------------|
| Texture scan on  |  | Will capture texture data.     |
| Texture scan off |  | Will not capture texture data. |



## Note

Texture switch cannot be changed once the project group been created.

## IR mode

The scanner support two scan targets: **Portrait scan**, **Object scan**.



You need to choose scan target when you create the project. With different scan target, the settings below will be different.

## Note

- You can select **Medium object** or **Large object** under object scan.
  - Medium object: size between 100mm X 100mm X 100mm and 300mm X 300mm X 300mm.
  - Large object: size larger than 300mm X 300mm X 300mm.

## Alignment

| Scan Mode     | Alignment                                               | Instruction                                                                                                                                                                                                  |
|---------------|---------------------------------------------------------|--------------------------------------------------------------------------------------------------------------------------------------------------------------------------------------------------------------|
| Portrait Scan | - Features<br>- Texture<br>- Hybrid                     | <b>Hybrid</b> alignment here means feature alignment plus texture alignment.                                                                                                                                 |
| Object Scan   | - Features<br>- Texture<br>- Hybrid<br>- Global Markers | - When select <b>Global Markers</b> alignment, if global marker file not import, you need to scan global marker file first.<br>- <b>Hybrid</b> alignment here means feature alignment plus marker alignment. |

## Note

**FEATURE ALIGNMENT** uses object geometric features for auto aligning during scanning. Rich features on the object are required for this mode.

**TEXTURE ALIGNMENT** uses objects surface texture to align the scans. Compared with feature alignment, texture alignment takes longer and consumes more memory. It is recommended to use the texture alignment only in cases where the object's geometrical features are insufficient. Texture Scan is required to select if you want to use texture align.

**GLOBAL MARKERS ALIGNMENT** uses global markers file to help align the scans. You may add a existed global markers file or scan one.

**HYBRID ALIGNMENT** uses two different alignments to align the scans. Use the function to avoid alignment error in some target parts. By this alignment, we do not need to place the markers all over the part, but only on the region where has less geometry. Global markers files can be imported to assist in scanning and aligning.



## Resolution

| Scan Mode     | Resolution                                | Instruction                                         |
|---------------|-------------------------------------------|-----------------------------------------------------|
| Portrait Scan | 0.2mm~3.0mm                               | 1.0mm by default                                    |
| Object Scan   | 0.2mm~3.0mm<br>0.2mm~0.5mm(Medium object) | 0.5mm by default<br>0.3mm by default(Medium object) |

## Note

- With smaller setting value, you will get more detail, but will lead to larger file size and longer processing time.
- Resolution cannot be changed once the project group been created.

## Texture

| Texture     | Icon                                                                                | Instruction                   |
|-------------|-------------------------------------------------------------------------------------|-------------------------------|
| Texture on  |  | will capture texture data     |
| Texture off |  | will not capture texture data |

**Note**

Texture switch cannot be changed once the project group been created.

# Scanning

# Scan setting

Following parameters can be set when scanning.

## Brightness

Adjust the brightness for different material / color of the object to get better scan data.

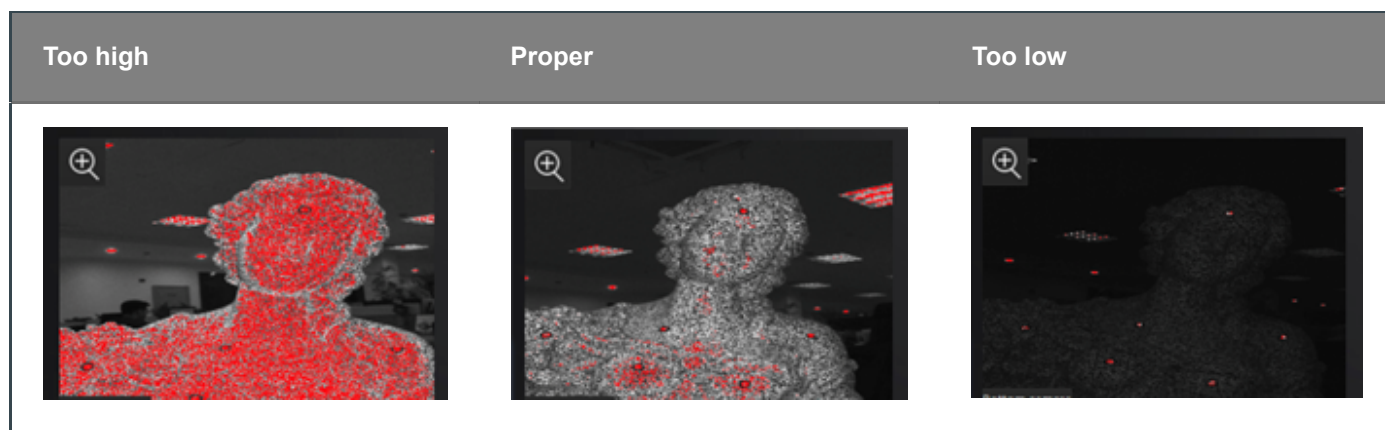

## Working distance

Use short working distance to get more detail, but need more time to scan the whole object.

Use long working distance to get large FOV, scan time will be shorter, but will lose some detail of the data.

| Scan Mode                | Minimum distance | Maximum distance              | Working distance range                                          |
|--------------------------|------------------|-------------------------------|-----------------------------------------------------------------|
| White light mode         | 200mm            | 700mm                         | $\geq 200\text{mm}$                                             |
| Portrait scan in IR mode | 200mm            | 1500mm                        | $\geq 200\text{mm}$                                             |
| Object scan in IR mode   | 200mm            | 700mm<br>450mm(Medium Object) | $\geq 200\text{mm}$<br>$\geq 40\text{mm}(\text{Medium Object})$ |



## Other function

| Function               | Value  | Instruction                                                                                                                                                                                                   |
|------------------------|--------|---------------------------------------------------------------------------------------------------------------------------------------------------------------------------------------------------------------|
| Data Quality Indicator | ON/OFF | To indicate the data quality of your scan, help you to get better scan data.<br>- Only available before generating point cloud.                                                                               |
| Texture LED Light      | ON/OFF | Please turn on the LED light when there is not enough light for better texture scanning ( This function is enabled by default).<br>- Only available when <b>texture on</b><br>- Cannot change during scanning |
| Hair Mode              | ON/OFF | Easier to scan hair, but also increase data noise.<br>- Only available in <b>Portrait Scan</b> .<br>- Cannot change during scanning.                                                                          |

# Scanning

## Preview / Scan / Pause

You can always switch in these 3 status with the trigger on the scanner, or click the button in the software. The basic switch order is: **Preview -- Scan -- Pause**

| Function | Icon                                                                              | Instruction                                                                                                                                                                                                                               |
|----------|-----------------------------------------------------------------------------------|-------------------------------------------------------------------------------------------------------------------------------------------------------------------------------------------------------------------------------------------|
| Preview  |  | In this mode, only show data for preview, but not record the data, you can modify the <a href="#">scan parameters</a> according to the preview.                                                                                           |
| Scan     |  | Start scanning, data is recorded. During scanning, make sure to keep the scanner perpendicular to the surface, keep a proper distance from the object, and adjust the brightness depending on the ambient light or texture of the object. |
| Pause    |  | Pause scanning, you can <a href="#">edit the scan data or change the view angle</a> if you want.                                                                                                                                          |



Preview

 **Caution**

When scanning the recessed areas of an object, please hold the scanner directly towards the area to be scanned.

## Generate point clouds

When you finish the scan, you can **Generate Point Clouds**<sup>1</sup> or **Optimize and Generate Point Clouds**<sup>2</sup>. You may want to [edit the data](#) later.

 **Note**

The time it takes to generate point cloud depends on the data size of your project and the hardware configuration of your PC.









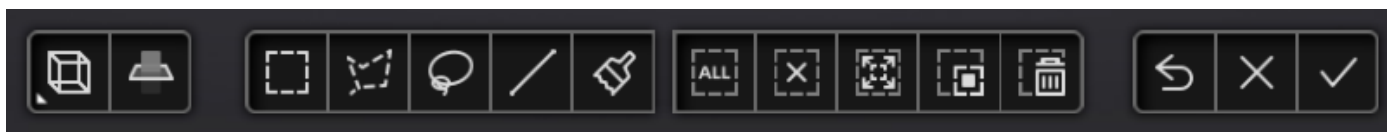







1. To generate point cloud directly without any optimization, will be fast and less memory been used; Only available in **Object Scan**. [←](#)
2. Optimize then generate point cloud, suggest choosing this option when you have higher accuracy requirement or when there is layering problem caused by accumulated aligning errors during scanning. [←](#)

# Scan data edit

We provide functions to edit the scan data when you pause scanning or after you generate point cloud.



| Icon                                                                                | Function             | Instruction                                                                                   |
|-------------------------------------------------------------------------------------|----------------------|-----------------------------------------------------------------------------------------------|
|    | Multi View           | There are 6 different view angles for you to choose.                                          |
|    | Create Cutting Plane | Create a plane to do quick cut, check <a href="#">below</a> for detail.                       |
|    | Rectangular          | Click and hold LMB to <b>drag</b> to select / deselect an area of the data.                   |
|    | Polygon              | Click LMB one-by-one to select / deselect an area of the data.                                |
|    | Lasso                | Click and hold LMB to <b>drag</b> to select / deselect an area of the data.                   |
|   | Straight Line        | <b>Drag</b> to create a line to select / deselect an area of the data.                        |
|  | Brush                | Use brush to select / deselect an area of the data.                                           |
|  | Select All           | Select all of the data.                                                                       |
|  | Unselect             | Cancel all the selections.                                                                    |
|  | Connected Domain     | Click the button after select data, all connected region to the selected data will be picked. |
|  | Revert               | Revert the selection.                                                                         |
|  | Delete               | Click the button or "DELETE" on the keyboard to delete selected data.                         |
|  | Undo                 | Click the button to undo the most recently operations.                                        |

| Icon                                                                              | Function | Instruction                                                          |
|-----------------------------------------------------------------------------------|----------|----------------------------------------------------------------------|
|  | Cancel   | Undo all edit, and exit edit mode.                                   |
|  | Apply    | Click the button or space bar to apply the edit, and exit edit mode. |

#### Note

- press **Shift** + LMB to select the area.
- press **Ctrl** + LMB to deselect the area.

## Cutting plane

Cutting plane is very useful when a base needs to be removed during scanning.

After setting cutting plane, there will be no more data scanned below the cutting plane.

### Create cutting plane

Three methods to create cutting plane:







| Method                    | Instruction                                                                                                                                                                                                                                  |
|---------------------------|----------------------------------------------------------------------------------------------------------------------------------------------------------------------------------------------------------------------------------------------|
| Fitting Point<br>Cloud    | Press Shift + LMB to select data, then click the button "Generate plane". The cutting plane will be created by point cloud fitting. The direction of the plane will be calculated by the software according to the direction of point cloud. |
| Creating<br>Straight Line | Press Shift + LMB to draw a line, and generate the cutting plane according to the line.                                                                                                                                                      |
| By Markers                | Press Shift + LMB to select markers.<br>3 markers or more are required to generate the cutting plane.                                                                                                                                        |

## Set cutting plane

| Method             | Instruction                                                                                                          |
|--------------------|----------------------------------------------------------------------------------------------------------------------|
| Rotation axis      | Cutting plane can be rotated around the axis by dragging the small ball.                                             |
| Move cutting plane | Move the cutting plane by operating the active bar, editing the text box or dragging the arrow.                      |
| Delete             | Click this option, data in the reverse direction will be shown in red. Apply this, and the red data will be deleted. |
| Reverse            | Reverse the normal direction of the cutting plane.                                                                   |
| Delete plane       | Delete the created cutting plane.                                                                                    |

# Scan functions





Before or after scanning, you can access the other scan functions through the sidebar function buttons.

| Icon                                                                                | Function      | Instruction                                                                                            |
|-------------------------------------------------------------------------------------|---------------|--------------------------------------------------------------------------------------------------------|
|    | Project Group | Create / open a project group.<br>About project group, please refer to <a href="#">Project Group</a> . |
|    | Clean Data    | Clean the current point cloud data to redo scan.                                                       |
|    | Align         | Align the data as you need, please refer to <a href="#">Align</a> .                                    |
|    | Save Data     | Save scan data.                                                                                        |
|   | Show Texture  | To show / hide texture on screen.                                                                      |
|  | Mesh          | Will move to next step "Post Processing" to <a href="#">mesh</a> .                                     |

# Align point cloud

This is how you align multiple projects in one project group.

Click  on the right side of the interface to enter the project alignment interface.

| Align Mode                                                                          | Instruction                                                                                                                                                       | Note                                                                                                                                                                                                                                                                                                                                                                                                    |
|-------------------------------------------------------------------------------------|-------------------------------------------------------------------------------------------------------------------------------------------------------------------|---------------------------------------------------------------------------------------------------------------------------------------------------------------------------------------------------------------------------------------------------------------------------------------------------------------------------------------------------------------------------------------------------------|
|    | Choose <b>Feature Alignment</b> and click <b>Apply</b> , alignment will be performed automatically.                                                               | Regular shaped objects (circular objects and square objects included) or small sized objects are not suitable for this mode.                                                                                                                                                                                                                                                                            |
|    | Manually choose at least 3 common points in the fixed window and floated window. Click Apply to align.                                                            | <ul style="list-style-type: none"><li>- The chosen points should NOT in a line.</li><li>- Manual alignment is a supplement to feature alignment, which can solve the problem of feature alignment failures such as some areas with few common areas or extremely similar areas. The data is aligned by the best fit of all points of the data in the floated viewport and the fixed viewport.</li></ul> |
|  | If the currently selected project is a marker project, the marker alignment can be performed. The software will automatically align according to the mark points. | The two projects have no less than 3 common markers each other.                                                                                                                                                                                                                                                                                                                                         |
|  | Select two project files and manually select multiple ( $\geq 3$ ) markers for alignment.                                                                         | <ul style="list-style-type: none"><li>- The selection of markers should be as separate and random as possible.</li><li>- The selected markers will be cleared after aligning.</li></ul>                                                                                                                                                                                                                 |

## Note

You should **generate point cloud** before doing **align**.



# Post Processing



# Mesh

Meshing is to convert the point cloud into a triangular mesh surface. The data after mesh can be directly used for rendering, measurement or printing.

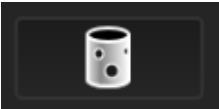
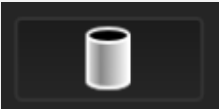
## Mesh type

| Icon                                                                               | Function        | Instruction                                                                                                                  |
|------------------------------------------------------------------------------------|-----------------|------------------------------------------------------------------------------------------------------------------------------|
|   | Unwaterproof    | Unclosed model stays the way it is scanned. Processing time is quicker than Waterproof.                                      |
|   | Half waterproof | Some of the holes will be filled automatically. Holes with a diameter less than or equal to the resolution*5 will be filled. |
|  | Waterproof      | All holes will be filled automatically. The data can directly be 3D printed. Only waterproof mesh can set model quality.     |

# Mesh optimization

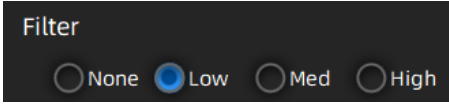
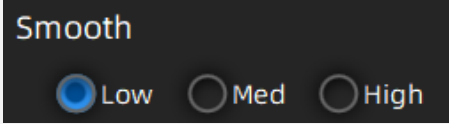
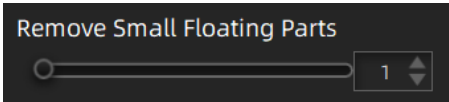
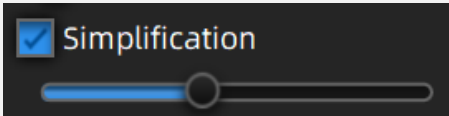
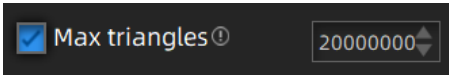
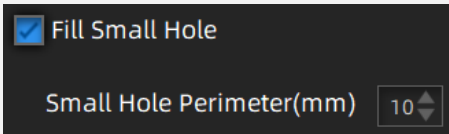
| Optimization                | Instruction                                                                                                                                                                                        | Note                                                                                                                                                                                                                                                                                                               |
|-----------------------------|----------------------------------------------------------------------------------------------------------------------------------------------------------------------------------------------------|--------------------------------------------------------------------------------------------------------------------------------------------------------------------------------------------------------------------------------------------------------------------------------------------------------------------|
| Filter                      | <p>Optimize the data and improve the clarity of the data. The higher the level, the less the small details .</p>  | <ul style="list-style-type: none"> <li>- None: No optimization</li> <li>- Low: Optimizes data slightly and preserves data characteristics</li> <li>- Med: Reduce the noise on the surface of the scan data</li> <li>- High: Reduce the noise on the surface of the scan data and sharpen it powerfully.</li> </ul> |
| Smooth                      | <p>Smooth the possible noise on the surface of the scan data.</p>                                                 |                                                                                                                                                                                                                                                                                                                    |
| Remove small floating parts | <p>Remove small floating parts on the model.</p>                                                                 |                                                                                                                                                                                                                                                                                                                    |
| Simplification              | <p>Select to reduce the polygon numbers, file size and detail of data while meshing.</p>                        | <ul style="list-style-type: none"> <li>- Resolution <math>\leq 0.5\text{mm}</math>, simplification will be selected by default.</li> <li>- Resolution <math>&gt; 0.5\text{mm}</math>, simplification will be deselected by default.</li> </ul>                                                                     |
| Max triangles               | <p>Set max plate number to get mesh model's triangle plate number is within configured plate number.</p>        |                                                                                                                                                                                                                                                                                                                    |
| Fill small hole             | <p>Auto fill the small hole when mesh.</p>                                                                      | <p>Default value 10mm, for objects with holes (smaller than 10 mm), please set the function parameter value to a smaller one.</p>                                                                                                                                                                                  |

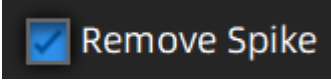
| Optimization     | Instruction                                                                                                                    | Note |
|------------------|--------------------------------------------------------------------------------------------------------------------------------|------|
| Remove spike     | Remove spike-like data on the image edge.<br> |      |
| Marker hole fill | Fill in the surface of the object that is not scanned to the pasting marker.                                                   |      |

Click **Apply** to confirm the settings and start meshing, you can click  to restore or click **Confirm** to confirm the mesh result.

# Mesh editing

## Left panel

Click + to open each function.

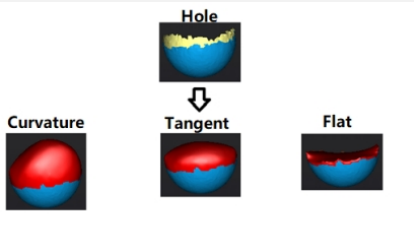
| Function                    | Instruction                                                                                                                                                 | Note                                                                                                                                                                                                                                                                                                                                                                                                                                                                      |
|-----------------------------|-------------------------------------------------------------------------------------------------------------------------------------------------------------|---------------------------------------------------------------------------------------------------------------------------------------------------------------------------------------------------------------------------------------------------------------------------------------------------------------------------------------------------------------------------------------------------------------------------------------------------------------------------|
| Texture                     | <b>Brightness</b> and <b>Contrast</b> can be adjusted.                                                                                                      | <b>Confirm</b> to apply, <b>Cancel</b> to restore                                                                                                                                                                                                                                                                                                                                                                                                                         |
| Simplification              | After simplification, the polygon numbers, file size and detail of data will be reduced universally.                                                        | High level may cause detail loss. Set the ratio from 1 to 100, the default is 0.                                                                                                                                                                                                                                                                                                                                                                                          |
| Mesh Optimization           | Mesh optimization can optimize the quality of the data by adding more triangles to curvature regions.                                                       |                                                                                                                                                                                                                                                                                                                                                                                                                                                                           |
| Smooth                      | Smooth the possible noise on the surface of the scan data.                                                                                                  | It might remove some small details or smooth some sharp edges at the same time. Set the ratio from 1 to 100, the default is 0.                                                                                                                                                                                                                                                                                                                                            |
| Remove small floating parts | Remove small floating parts in the scan data.                                                                                                               | From 0 to 100% where 100% is the size of the largest mesh island. Smaller islands will be removed. 0 means no operation, 100 is the maximum. The maximum value is the square of the diagonal length of the floating part/10, $MAX=(L/10)^2$ .                                                                                                                                                                                                                             |
| Auto Hole Filling           | Auto fill every hole with a smaller perimeter than the number input.<br> | Choose Curvature, Tangent or Flat before filling hole.<br>- <b>FLAT</b> : calculates the solution for the hole filling considering the point position on the boundary.<br>- <b>TANGENT</b> : calculates the solution considering the point position and the normal of the last row of triangles forming the boundary.<br>- <b>CURVATURE</b> : calculates the solution considering the point position and the normal of the 2 last rows of triangles forming the boundary. |
| Manual Hole Filling         | The hole edges are displayed green and get red after picking. The number of the holes and the number of holes filled will be displayed on the interface.    | Choose Curvature, Tangent or Flat before picking a hole.                                                                                                                                                                                                                                                                                                                                                                                                                  |
| Flip Normal                 | To redefine the front direction of the scanned data in reversal design.                                                                                     | Texture mapping will be unavailable after flip Normal                                                                                                                                                                                                                                                                                                                                                                                                                     |

| Function           | Instruction                                                                                                                                                  | Note                                                    |
|--------------------|--------------------------------------------------------------------------------------------------------------------------------------------------------------|---------------------------------------------------------|
| Cutting Plane Tool | Define a plane by drawing a straight line. Delete the selection and close the mesh at the intersection. Use the cutting plane to align the mesh to the CSYS. |                                                         |
| Mirror             | Mirror the mesh through a plane defined by a straight line.                                                                                                  | After mirroring, texture remapping cannot be performed. |

## Bottom panel

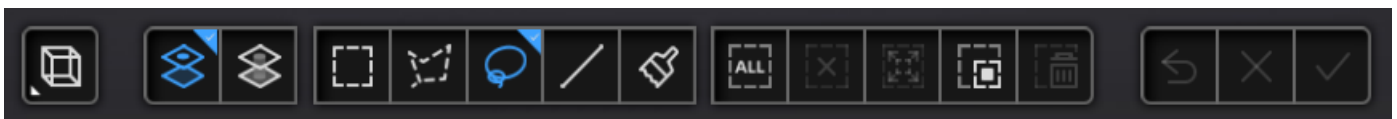







| Icon | Function       | Instruction                            |
|------|----------------|----------------------------------------|
|      | Select Visible | To select data on the front view only. |
|      | Select through | To select data all through.            |

### Note

The other editing functions are the same as [point cloud editing](#)

## Right panel

| Icon                                                                              | Function             | Instruction                                                                                                                                                                            |
|-----------------------------------------------------------------------------------|----------------------|----------------------------------------------------------------------------------------------------------------------------------------------------------------------------------------|
|  | Open file            | Open a file (STL, OBJ, PLY) for post processing.                                                                                                                                       |
|  | Save Data            | Save scan data.                                                                                                                                                                        |
|  | Sketchfab Upload     | Use your <a href="https://sketchfab.com">Sketchfab (https://sketchfab.com)</a> account to share the model.                                                                             |
|  | Third-party software | Save the data and open with third-party software.                                                                                                                                      |
|  | Texture remapping    | After the post-processing, hole filling on texture scanned data will affect the texture render. By doing the texture remapping, the texture information will be reapplied on the mesh. |
|  | Show Texture         | To show / hide texture on screen.                                                                                                                                                      |

# Measurement



You can measure on the model you just scanned, or you can open a model file to do the measurement.

Click to select the file to be measured; or directly drag the file (STL, OBJ, PLY) to the measurement interface.

## Create Features

Click  to display the menu of creating features. To close the menu, please click the icon again, or click **Close**.

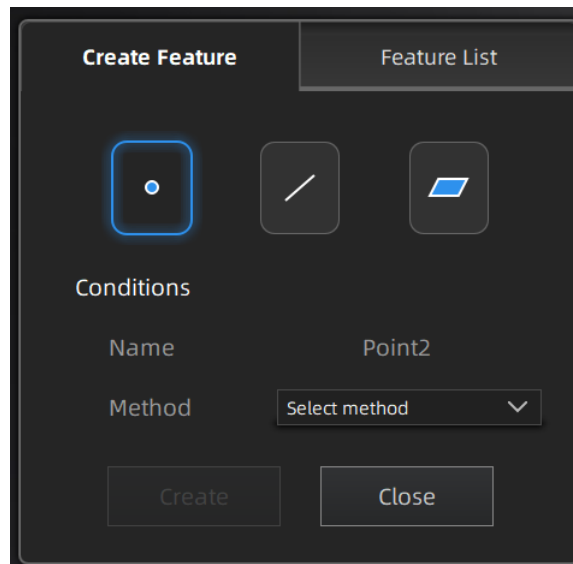

## Point

| Creation Method         | Description                                                                                                                                                                                                                                                               | Note                                                                                           |
|-------------------------|---------------------------------------------------------------------------------------------------------------------------------------------------------------------------------------------------------------------------------------------------------------------------|------------------------------------------------------------------------------------------------|
| Selected Points         | <ul style="list-style-type: none"><li>• Click on the data to select a point.</li><li>• Click <b>Create</b> to create a point.</li></ul>                                                                                                                                   | -                                                                                              |
| Line-Plane Intersection | <ul style="list-style-type: none"><li>• Click on the created line, or select it on the dropdown.</li><li>• Click on the created plane, or select it on the dropdown.</li><li>• The point generated is the intersection between the non-parallel line and plane.</li></ul> | Line and Plane should be created in advanced.<br>The line should not be parallel to the plane. |

## Line

| Creation Method          | Description                                                                                                                                                                                                                                                                                              | Note                                                                                        |
|--------------------------|----------------------------------------------------------------------------------------------------------------------------------------------------------------------------------------------------------------------------------------------------------------------------------------------------------|---------------------------------------------------------------------------------------------|
| Point-Point              | <ul style="list-style-type: none"><li>• Pick 2 points.</li><li>• Click on the data to select a point or click on a feature point previously created.</li><li>• In the Choice list select one of the points to redo it.</li><li>• The line generated is define as point from to point to point.</li></ul> | -                                                                                           |
| Plane-Plane Intersection | <ul style="list-style-type: none"><li>• Click on the plane previously created, or select it on the dropdown, repeat for the second plane.</li><li>• The created line is the intersection between the 2 non-parallel planes.</li></ul>                                                                    | 2 planes should be created in advanced.<br>The planes should not be parallel to each other. |

## Plane

| Creation Method | Description                                                                                                                                                                                                                                                                                                                                                                                                         | Note                                    |
|-----------------|---------------------------------------------------------------------------------------------------------------------------------------------------------------------------------------------------------------------------------------------------------------------------------------------------------------------------------------------------------------------------------------------------------------------|-----------------------------------------|
| 3 Points Fit    | <ul style="list-style-type: none"><li>• The plane is generated by 3 points not co-linear.</li><li>• Click on the data to select one point or click on a previous created feature point.</li><li>• In the Choice list select one of the points to reselect it.</li></ul> <b>Feature creation failed! Error code 6:</b> the points selected are co-linear.                                                            | The 3 points can't be on the same line. |
| Point-Line Fit  | <ul style="list-style-type: none"><li>• The plane generated includes the point and the line (The line should be created in advanced).</li><li>• Click on the line previously created or select it from the drop-down.</li><li>• Click on the data to select a point or click on a feature point previously created.</li></ul> <b>Feature creation failed! Error code 6:</b> the point selected belongs to the line. | Line should be created in advanced      |
| Best Fit        | <ul style="list-style-type: none"><li>• The plane generated is the position with the smallest deviation from the selected area.</li></ul>                                                                                                                                                                                                                                                                           | -                                       |

# Movement

Use this mode to modify the alignment of the data to the global coordinate. This action is useful for post processing or reverse engineering.



## Caution

- The shape and accuracy of the model will not be changed by the movement.
- After the movement and exiting, the changes are irreversible so you can only reset the model by reloading the original file.

Click  to enter the movement interface. Click it again to exit.

## Exact Movement

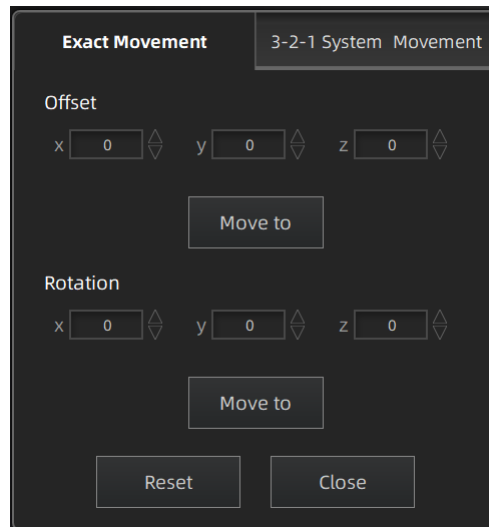

Click "Move to" to align the model center with the input coordinates, and the axis direction is adjusted to match the input rotation angle.

The coordinate system displayed on the interface is the global coordinate system, in which the direction of the red line is the positive direction of X-axis, green is the positive direction of Y-axis and blue is the positive direction of Z-axis.

Click **Reset** to cancel all the transformation in the exact movement interface.

Click **Close** to save the results and exit.

## 3-2-1 System Movement

3-2-1 system movement aligns data by selecting the point, line and plane. Before movement, create feature points, lines and planes. The feature lines created are not perpendicular to the plane.

The coordinate system on the interface represents the global coordinate system: Red=X+, Green=Y+, Blue=Z+.

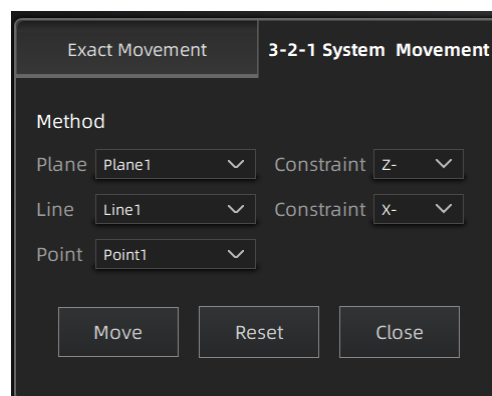

- Select a feature surface in the plane drop-down menu, and select an axis in the corresponding constraint drop-down menu of the plane. The arrow on the plane corner indicates the positive direction of the plane, and the selected axis direction will be consistent with the plane direction.

- Select a feature line in the drop-down menu of the line, and select an axis in the drop-down menu of the line. The arrow of the line indicates the positive direction of the line, and the direction of the selected axis will be consistent with the direction of the projection of the line on the selected plane.
- Click the drop-down menu to select a point, the position of this point is the origin of the coordinates (0, 0, 0).

Click **Movement** to start the coordinates transformation. When the lines are perpendicular to the plane, the transformation fails, so the movement fails.

Click **Reset** to cancel all the transformation in the 3-2-1 system movement interface.

Click **Close** to save the results and exit.

# Measurement

Click  to enter the measurement interface and the menu is displayed. Click it again to exit.

| Measurement  | Description                                                                                                                                                                                                                                              | Steps                                                                                                                                                                                                                                                                                                                        |
|--------------|----------------------------------------------------------------------------------------------------------------------------------------------------------------------------------------------------------------------------------------------------------|------------------------------------------------------------------------------------------------------------------------------------------------------------------------------------------------------------------------------------------------------------------------------------------------------------------------------|
| Distance     | Calculate the distance between two points on the surface of the model. <ul style="list-style-type: none"><li>• <b>Total</b> is the 3D distance.</li><li>• <b>X, Y</b> and <b>Z</b> are the projection of the segment to the respective planes.</li></ul> | Click on the surface of the model to pick two points, the calculation will be done automatically.                                                                                                                                                                                                                            |
| Surface Area | Calculate the surface area value.                                                                                                                                                                                                                        | <ul style="list-style-type: none"><li>• Press <b>Shift + left mouse button(LMB)</b> and move the cursor to select an area</li><li>• Press <b>Ctrl + left mouse button(LMB)</b> and move the cursor to unselect.</li><li>• <b>Ctrl + A</b> to select all.</li><li>• Press <b>Ctrl + C</b> to deselect all the date.</li></ul> |
| Volume       | Calculate the volume of the <b>watertight data</b> .                                                                                                                                                                                                     | It returns the volume in mm <sup>3</sup> and the coordinates of the bounding box.<br> <b>Note:</b><br>Only available for <b>watertight mesh</b> .                                                                                         |